

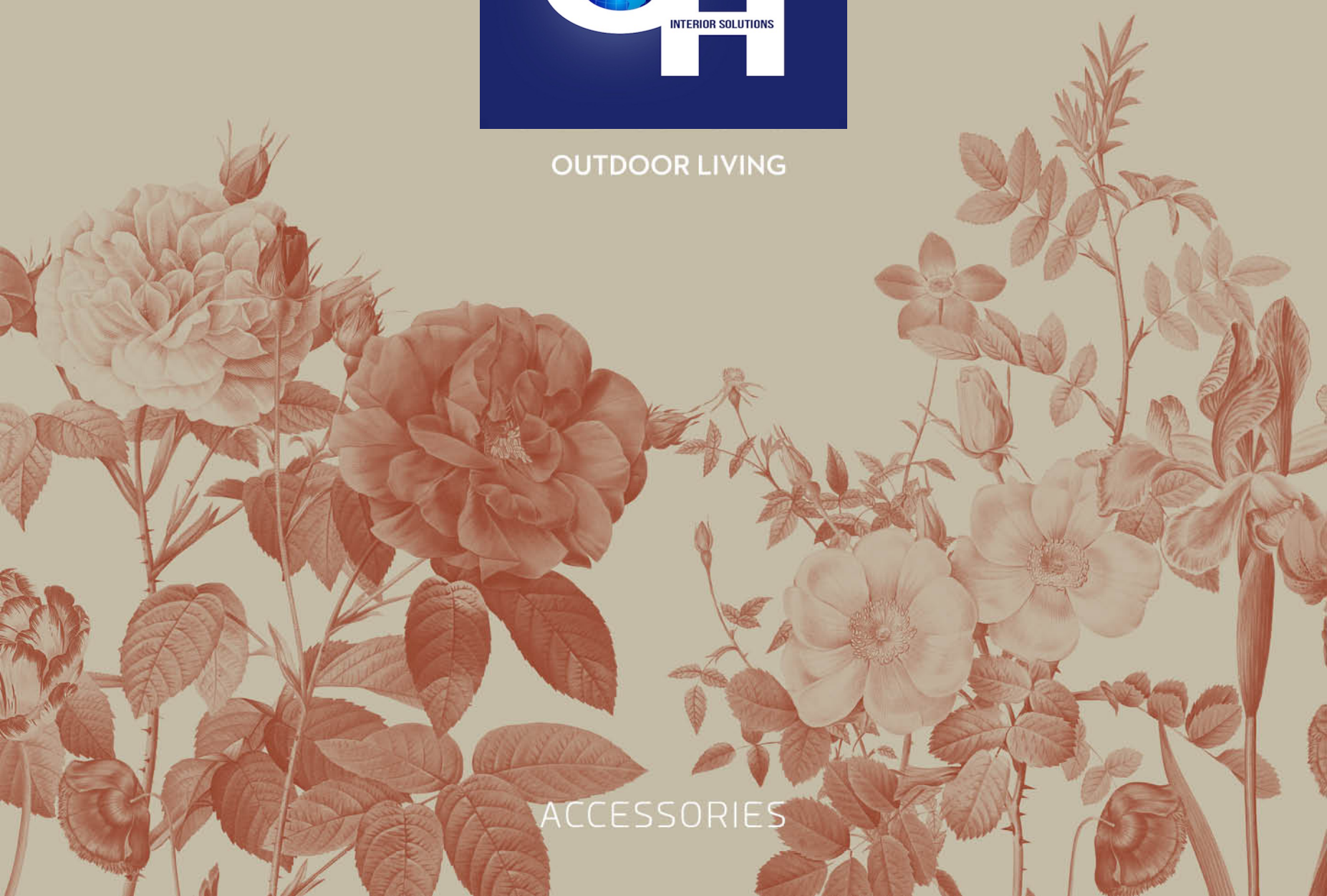

OUTDOOR LIVING



ACCESSORIES



OUTDOOR LIVING

ACCESSORIES

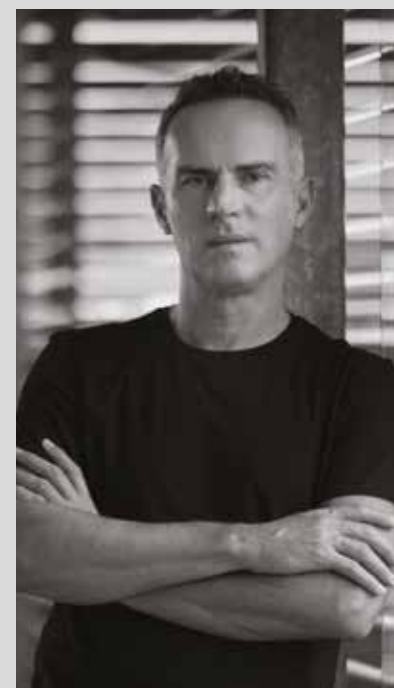

LUDOVICA SERAFINI + ROBERTO PALOMBA

MARCO ACERBIS

CHRISTOPHE PILLET

RAMÓN ESTEVE

FILIPPO CAGNOTTO

FRANCESCO FAVARETTO

CRISTIAN VISENTIN

Argo	Frame	Panama	Tribal
Capri	George	Salinas	Tweet
Cruise	Karen	Scacco	Venice
Cliff	Malè	Skyline	
Elton	Nalu	Slam	
Flow	Nido	Swipe	

Alabama	Coral	Milo	Thea
Bond	Jun	MrX	Tod
Cleo	Leaf	Reef	

Allure  
Ever

Casilda  
Cottage

Path

Snap

Moon

# — TALENTI'S — DESIGNERS TEAM —



CARLO COLOMBO

TERESA SAPEY

JEAN PHILIPPE NUEL

KARIM RASHID

NICOLA DE PELLEGRINI

NICCOLÒ ADOLINI

MARIATERESA CASAROLA

Itaca  
Tressé

Nami

Riviera

Breez

Tikal

Kukà  
Musa

Chora

# INDEX

▲ Mr X	07	Coral//lamps	191
Skyline	17	Tofee//lamps	199
Ermes//parasol	31	Swan//lamps	205
Eros//parasol	43	Snap	213
Zeus//parasol	51	Plaza	221
Athena //parasol	59	Parker	231
Venere//parasol	71	Gabri	237
Marte//parasol	77	Sylvie	243
Vulcano//parasol	87	Musa	249
Apollo//parasol	93	Jackie	257
Carpets	101	Scacco	283
Casilda//lamps	125	Chora	291
Tribal//lamps	131	Tikal	303
Cleo//lamps	143	Showergate	313
Kukà//lamps	153	Path	319
Malè//lamps	169	Cart	327
Tod//lamps	179	Ray	335
Dolcevita//lamps	185	Box	341



**MrX**collection  
Design Marco Acerbis



# MrXcollection

sun sail  
graphite colour





# MrXcollection

## Design Marco Acerbis



MRX / CODE: MRX01



	Width	Depth	Height
cm	380	280	240
inch	149.6	110.2	94.5



### Finishing

Aluminium frame



white



grahite

canopy



white

### SISTEMA DI APERTURA / OPENING SYSTEM

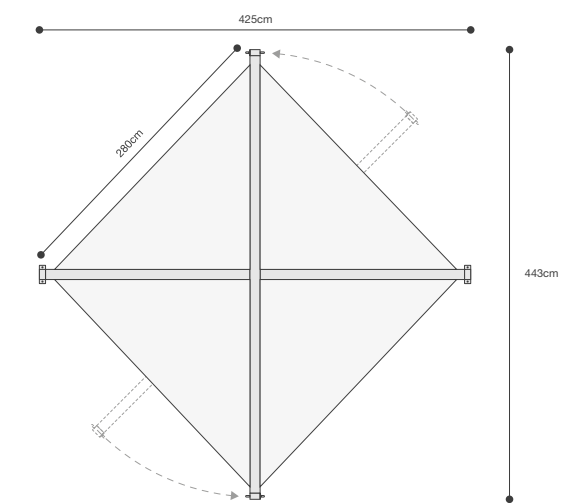
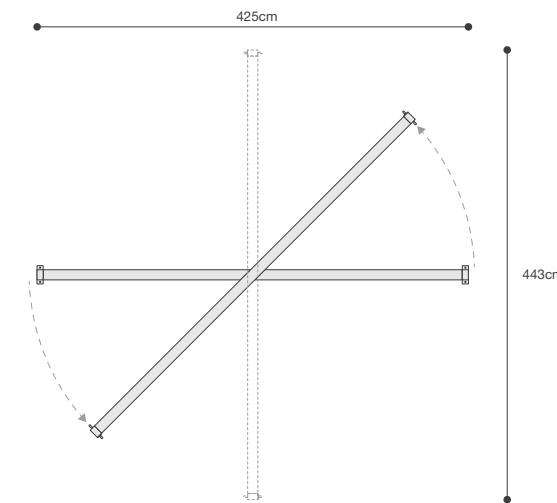

- 1 - Copertura massima vela 2,8x2,8 m.
- 2 - Illuminazione led da 20W con profilo su trave superiore, alimentazione a batteria ricaricabile estraibile, accensione con telecomando.
- 3 - Alla base dei due pali la struttura è provvista di piastre per l'ancoraggio al suolo tramite tasselli.
- 4 - Apertura con sistema a compasso.
- 5 - Due pali con ruota alla base per facilitare l'apertura della struttura.
- 6 - Sistema di apertura/chiusura vele tramite avvolgitore manuale.
- 7 - Telo 100% PET Tinto Massa idrorepellente da 220 gr/mq

Specifiche:  
 Peso della struttura 60kg  
 Pali in alluminio con profilo 100x60 mm  
 Altezza della struttura 230cm  
 In caso di condizioni avverse avvolgere le vele per evitare danni alla struttura, cose e persone.

- 1 - Maximum coverage of the canopy 2.8x2.8 m.
- 2 - 20W led lighting with profile on upper beam, power supply with removable rechargeable battery, ignition with remote control.
- 3 - At the base of the two poles, the structure is supplied with plates designed for the floor fastening through anchoring dowels.
- 4 - Compass opening system.
- 5 - To facilitate the opening system, the structure is equipped with two rotating poles provided with wheels.
- 6 - Sail opening and closing system with manual crank.
- 7 - Canopy 100% PET Solution Dyed FR water-repellent 220 gr/mq

Technical specifications:  
 Structure weight 60kg  
 Aluminium Pole 100x60 mm  
 Height of the structure 230cm  
 In case of bad weather conditions, we strongly recommend to roll up the sails in order to avoid damages to the structure, to objects and persons.



**Skyline**collection  
Design Ludovica Serafini + Roberto Palomba









# Skylinecollection

Design Ludovica Serafini + Roberto Palomba

## Finishing

Aluminium frame



red white dove grahite

Micro-perforated fabric canopy



white taupe red

1-Il telo è una membrana composita micro-forata. Peso 360 g/m<sup>2</sup> e spessore di 0,45mm.  
 2-Un lembo del telo è provvisto di un asola per inserire il tubolare di alluminio.  
 L'altro lembo è provvisto di una speciale cucitura che si inserisce nella sede di un profilo ad-hoc di alluminio.  
 3-Il tensionamento dei teli avviene ruotando il profilo ad-hoc sul proprio asse. La ruota dentata inserita negli snodi garantisce tenuta e regolazione.

1-The fabric is a micro-perforated composite membrane. Weight 360 g/m<sup>2</sup> and thickness of 0.45mm.  
 2-One edge of the sheet is provided by a slot in order to insert the aluminum tubing.  
 The other flap is provided with a special stitching that fits into the seat of an ad-hoc profile of aluminium.  
 3-The tensioning of the sheets occurs by rotating the ad-hoc profile on its axis. The cogwheel inserted into the joints it guarantees tightness and adjustment.

Specifiche:  
 Struttura in alluminio.  
 Telo PES + PVC coating.

In caso di condizioni avverse liberare il telo per evitare danni alla struttura, a cose e persone.

Technical specifications:  
 Aluminium structure.  
 Canopy PES + PVC coating.

In case of bad weather conditions, we strongly recommend to close the parasol in order to avoid damages to the structure, to objects and persons.

MODULE A 280X190 H240 / CODE: SKYMODA



MODULE A1 280X190 H310 / CODE: SKYMODA1

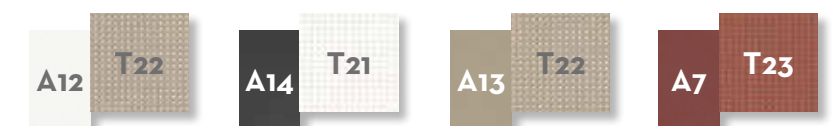

MODULE B 280X280 H240 / CODE: SKYMODB



MODULE B1 280X280 H310 / CODE: SKYMODB1



MODULE C 380X190 H240 / CODE: SKYMODC

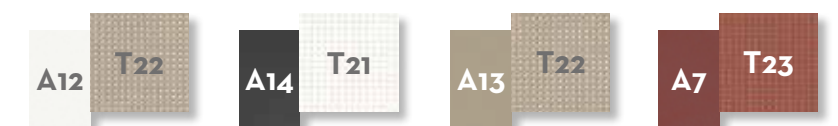

MODULE C1 380X190 H310 / CODE: SKYMODC1



MODULE D 380X280 H240 / CODE: SKYMODD



	Width	Depth	Height
cm	380	280	240
inch	149.6	110.2	94.5

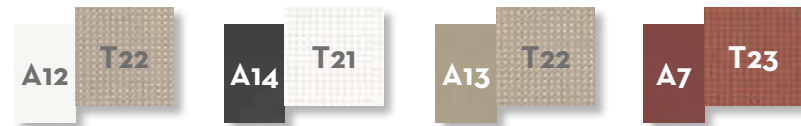

MODULE D1 380X280 H310 / CODE: SKYMODD1



	Width	Depth	Height
cm	380	280	310
inch	149.6	110.2	122.0



PARTITION H240 / CODE: SKYMODPAR



	Width	Depth	Height
cm	556	280	240
inch	218.9	110.2	94.5



COMPOSITION 1 - 465x280 H240/310 / CODE: SKYCOM1  
MODULI / MODULS: A+B1



COMPOSITION 6 - 375x465 H240/310 / CODE: SKYCOM6  
MODULI / MODULS: C1+D



COMPOSITION 2 - 550x280 H240/310 / CODE: SKYCOM2  
MODULI / MODULS: B+B1



COMPOSITION 7 - 375x550 H240/310 / CODE: SKYCOM7  
MODULI / MODULS: D1+D



COMPOSITION 3 - 650x280 H240/310 / CODE: SKYCOM3  
MODULI / MODULS: A+A+B1



COMPOSITION 8 - 650x375 H240/310 / CODE: SKYCOM8 (photo pag. 8-9)  
MODULI / MODULS: C1+C1+D



COMPOSITION 4 - 740x280 H240/310 / CODE: SKYCOM4  
MODULI / MODULS: B1+A+B1



COMPOSITION 9 - 650x375 H240/310 / CODE: SKYCOM9 (photo pag. 10-11)  
MODULI / MODULS: D1+C+C



COMPOSITION 5 - 740x465 H240/310 / CODE: SKYCOM5  
MODULI / MODULS: A+B1+A+B1+A



COMPOSITION 10 - 925x560/650 H240/310 / CODE: SKYCOM10 (photo pag. 6-7)  
MODULI / MODULS: D+C+C+D+A1+A1+A1





**Parasol**collection

//Ermes

Design Ludovica Serafini + Roberto Palomba





Parasolcollection  
//Ermes





# Parasolcollection

//Ermes

## Finishing

Aluminium frame



white



dove



grahite

Cement base



white



dove



graphite

Waterproof fabric canopy

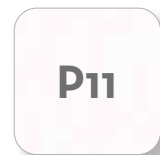

white



dark grey



dove



red



blue



castle white



warm white

Fabric for pouf

## Features

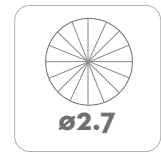
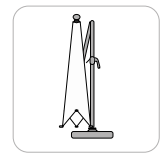

1-Telo ø2.7 in tessuto da 260g in acrilico 100%.

2 - Sistema di apertura semplice ed intuitivo, spingere il cappello dell'ombrellone verso l'alto finché il meccanismo non si arresta. Perno di sicurezza per impedire la chiusura accidentale del cappello dell'ombrellone.

3 - Palo prolunga ombrellone disponibile in 2 misure 20 cm o 40 cm.

4 - Optional: copertura basamento in alluminio.

5 - Optional: illuminazione a batteria ricaricabile.

6 - Optional: illuminazione con impianto audio per collegamento dispositivi Bluetooth.

7 - Optional: copertura basamento in alluminio ø63 cm x H 11 cm

Basamento in cemento (50 kg) con ruote.

1- Canopy ø2.7 in 260g polyester with acrylic 100%.

2 - Easily parasol opening: push upwards the parasol cap until it locks. Safety pin to prevent the parasol cap from closing accidentally.

3 - Pole extension parasol available in 2 sizes 20 cm or 40 cm.

4 - Optional:aluminium base cover.

5 - Optional: parasol light with rechargeable battery.

6 - Optional: parasol bluetooth speaker with led lights.

7 - Optional: cover base in aluminium ø63 cm x H 11 cm

Concrete base (50 kg) with wheels.

Specifiche:

Palo in alluminio ø48 mm

24 Stecche in alluminio 6,3x10 mm

Telo UPF50+

Altezza ombrellone 263/283/303 cm

Palo prolunga ombrellone 20 cm o 40 cm

Basamento cemento 50 kg ø60x9 cm

Ruote a 360° H 80 mm

In caso di condizioni avverse chiudere l'ombrellone per evitare danni alla struttura, a cose e persone.

Technical specifications:

Aluminium pole ø48 mm

No.24 aluminium ribs 6,3x10 mm

UPF50+ canopy

Parasol height 263/283/303 cm

Pole extension parasol 20 cm or 40 cm

Concrete base 50 kg ø60x9 cm

Wheels at 360° H 80 mm

In case of bad weather conditions, we strongly recommend to close the parasol in order to avoid damages to the structure, to objects and person.

ERMES D2.7 / CODE: PARERM



Optional fabric canopy

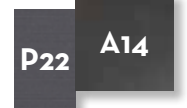
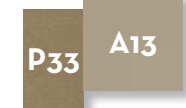
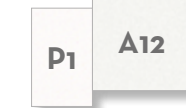

ERMES POUF / CODE: PARERMPUF



	Width	Depth	Height	H. seat	H. cushion
cm	132	132	43	43	7
inch	51.9	51.9	16.9	16.9	2.7

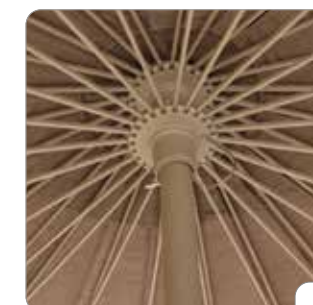
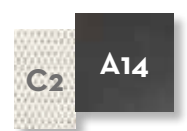
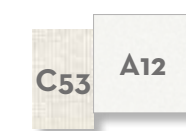



**Parasol**collection  
// Eros





Parasolcollection  
// Eros

# Parasolcollection

// Eros

EROS 3,5x3,5 / CODE: PARERO



## Finishing

Aluminium frame

Waterproof fabric canopy



## Features



- 1-Telo 3,5x3,5 in tessuto da 250g in poliestere trattato in PU.
- 2-Optional: illuminazione a batteria ricaricabile.
- 3-Sistema di apertura retrattile che permette la chiusura parallela al palo.
- Apposite guide di scorrimento ne facilitano lo spostamento.
- 4-Sistema di apertura e chiusura del telo tramite manovella manuale removibile.
- Il palo girevole permette all'ombrellone di ruotare di 360°.
- 5-Basamento in acciaio di colore bianco 90x90 cm. Per una stabilità ottimale si consiglia l'utilizzo di n.8 piastre in graniglia 50x50x5cm (pesi non inclusi).
- 6-Optional: illuminazione con impianto audio per collegamento dispositivi bluetooth.

- 1-Canopy 3,5x3,5 in 250g polyester with PU coating.
- 2-Optional: umbrella lights with rechargeable battery.
- 3-Retractable opening system allows umbrella closure parallel to the pole.
- Sliding guides make movements easier.
- 4-Canopy opening/closure with removable hand crank.
- Turning pole allows parasol a 360° rotation.
- 5-Steel base in white colour 90x90cm. For a better stability we recommend you to use 8 grit plates 50x50x5cm (weights not included).
- 6-Optional: umbrella bluetooth speaker with led lights.

Specifiche:  
 Palo in alluminio 120x76 mm  
 7 Stecche in alluminio 20x35 mm  
 Telo UV80+  
 Altezza ombrellone 307 cm  
 Basamento in acciaio 90x90x12 cm  
 (Pesi non inclusi)  
 In caso di condizioni avverse chiudere l'ombrellone per evitare danni alla struttura, a cose e persone.

Technical specifications:  
 Aluminium Pole 120x76 mm  
 No.7 alu ribs 20x35 mm  
 UV80+ Canopy  
 Parasol height 307 cm  
 Steel base 90x90x12 cm  
 (weights not included)  
 In case of bad weather conditions, we strongly recommend to close the parasol in order to avoid damages to the structure, to objects and persons.





**Parasol**collection  
// Zeus



Parasolcollection  
// Zeus

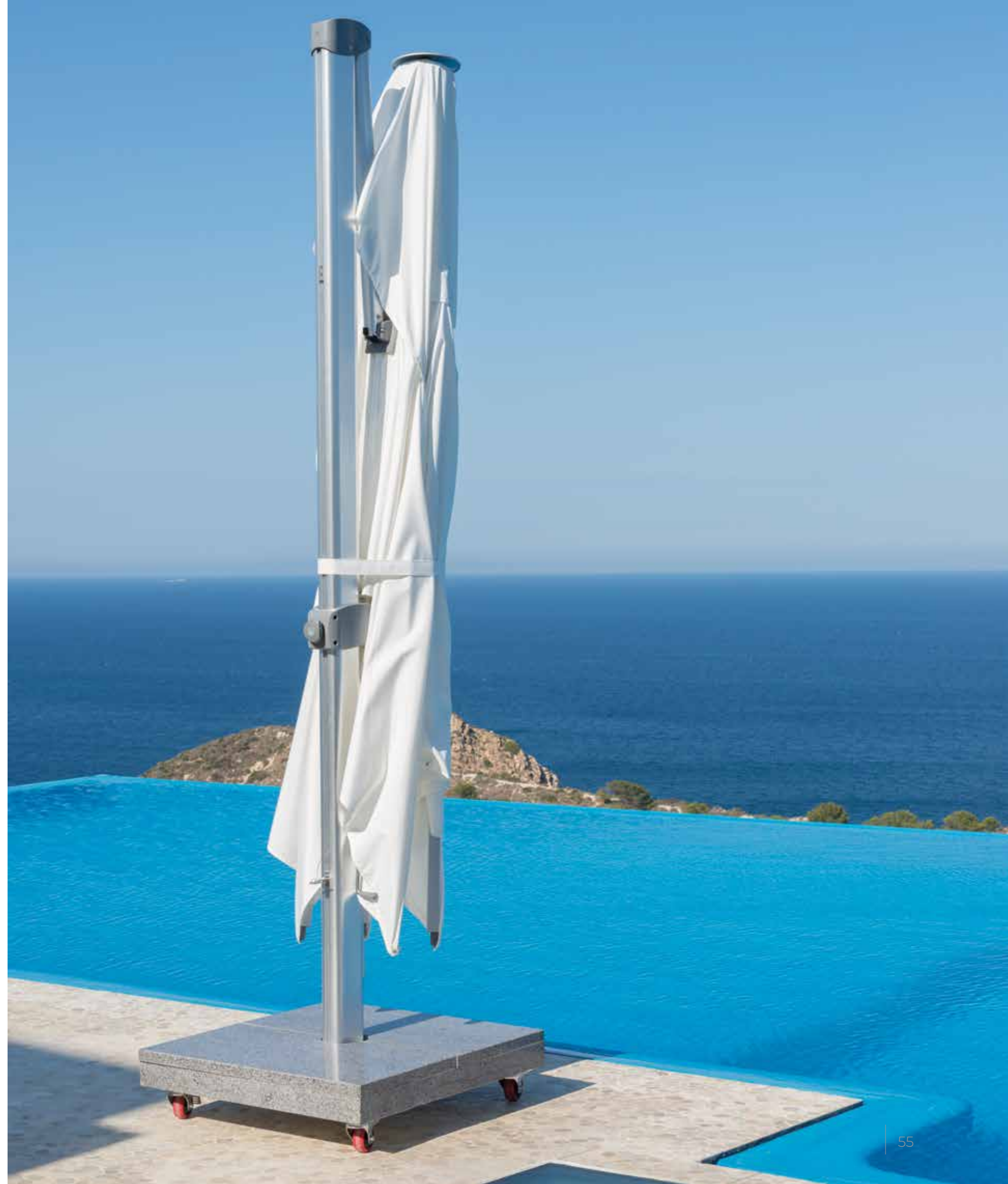

# Parasolcollection

// Zeus

## Finishing

Aluminium frame

Waterproof fabric canopy



anodized

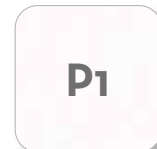

white

## Features

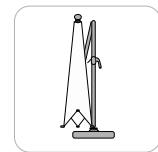

- 1-Telo 3x4 o 4x4 in tessuto da 250g in poliestere trattato in PU.
- 2-Optional: illuminazione a batteria ricaricabile.
- 3-Sistema di apertura retrattile che permette la chiusura parallela al palo. Apposite guide di scorrimento ne facilitano lo spostamento.
- 4-Sistema di apertura e chiusura del telo tramite manovella manuale removibile. Il palo girevole permette all'ombrellone di ruotare di 360°.
- Basamento in granito (180kg) con ruote.
- 5-Optional: illuminazione con impianto audio per collegamento dispositivi bluetooth.

- 1-Canopy 3x4 or 4x4 in 250g polyester with PU coating.
- 2-Optional: umbrella lights with rechargeable battery.
- 3-Retractable opening system allows umbrella closure parallel to the pole. Sliding guides make movements easier.
- 4-Canopy opening/closure with removable hand crank.
- Turning pole allows parasol a 360° rotation. Granite base (180kg) with wheels.
- 5-Optional: umbrella bluetooth speaker with led lights.

Specifiche:  
 Palo in alluminio 120x76 mm  
 7 Stecche in alluminio 20x35 mm  
 Telo UV80+  
 Altezza ombrellone 300 cm  
 Basamento granito 180 kg 80x80x10 cm  
 In caso di condizioni avverse chiudere l'ombrellone per evitare danni alla struttura, a cose e persone.

Technical specifications:  
 Aluminium Pole 120x76 mm  
 No.7 alu ribs 20x35 mm  
 UV80+ Canopy  
 Parasol height 300 cm  
 Granite base 180 Kg 80x80x10 cm  
 In case of bad weather conditions, we strongly recommend to close the parasol in order to avoid damages to the structure, to objects and persons.

ZEUS 3x4 / CODE: PARZES-A

KG 228,0

unit 1+1+1+1  
0.53 mc



•80x80•

P1 A10

ZEUS 4x4 / CODE: PARZES2-A

KG 240,0

unit 1+1+1+1  
0.53 mc



•80x80•

P1 A10





**Parasol**collection  
// Athena









# Parasolcollection

## // Athena

ATHENA 3x4 / CODE: PARATH



### Finishing

Aluminium frame



Waterproof fabric canopy



### Features

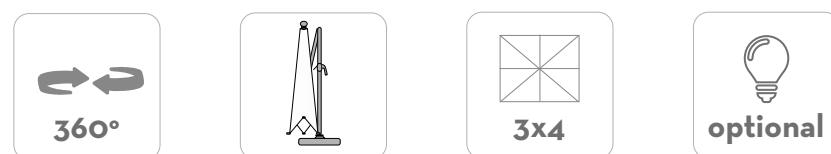

- 1-Telo 3x4 in tessuto da 250g in poliestere trattato in PU.
- 2-Optional: illuminazione a batteria ricaricabile.
- 3-Sistema di apertura retrattile che permette la chiusura parallela al palo.
- Apposite guide di scorrimento ne facilitano lo spostamento.
- 4-Sistema di apertura e chiusura del telo tramite manovella manuale removibile.
- Il palo girevole permette all'ombrellone di ruotare di 360°.
- 5-Optional: illuminazione con impianto audio per collegamento dispositivi Bluetooth.
- 6-Basamento in acciaio di colore bianco o tortora. Per una stabilità ottimale si consiglia l'utilizzo di n.10 piastre in graniglia 50x50x3,5cm (pesi non inclusi).

- 1-Canopy 3x4 in 250g polyester with PU coating.
- 2-Optional: umbrella lights with rechargeable battery.
- 3-Retractable opening system allows umbrella closure parallel to the pole.
- Sliding guides make movements easier.
- 4-Canopy opening/closure with removable hand crank.
- Turning pole allows parasol a 360° rotation.
- 5-Optional: umbrella Bluetooth speaker with led lights.
- 6-Steel base in white or dove colour. For a better stability we recommend you to use 10 grit plates 50x50x3,5cm (weights not included).

- Specifiche:
- Palo in alluminio 120x76 mm
  - 7 Stecche in alluminio 20x35 mm
  - Altezza ombrellone 310 cm
  - Telo UV80+
  - Basamento in acciaio 55x133x20 cm (Pesi non inclusi)
  - In caso di condizioni avverse chiudere l'ombrellone per evitare danni alla struttura, a cose e persone.

- Technical specifications:
- Aluminium Pole 120x76 mm
  - No.7 alu ribs 20x35 mm
  - Parasol height 310 cm
  - UV80+ Canopy
  - Steel base 55x133x20 cm (weights not included)
  - In case of bad weather conditions, we strongly recommend to close the parasol in order to avoid damages to the structure, to objects and persons.





**Parasol**collection  
// Venere



# Parasolcollection

## // Venere

VENERE 3x3 / CODE: PARVEN



### Finishing

Aluminium frame

Waterproof fabric canopy



### Features



- 1-Telo 3x3 in tessuto da 250g in poliestere trattato in PU.
- 2-Optional: illuminazione a batteria ricaricabile.
- 3-Sistema di apertura retrattile che permette la chiusura parallela al palo. Sistema di apertura e chiusura del telo tramite manovella manuale removibile. Inclinabile fino a 50° su ambedue i lati.
- Il palo girevole permette all'ombrellone di ruotare di 360°.
- 4-Basamento in granito (125 kg) con ruote.
- 5-Optional: illuminazione con impianto audio per collegamento dispositivi Bluetooth.

- 1-Canopy 3x3 in 250g polyester with PU coating.
- 2-Optional: umbrella lights with rechargeable battery.
- 3-Retractable opening system allows umbrella closure parallel to the pole. Canopy opening/closure with removable hand crank. Reclining up to 50° on both sides. Turning pole allows parasol a 360° rotation.
- 4-Granite base (125 kg) with wheels.
- 5-Optional: umbrella Bluetooth speaker with led lights.

Specifiche:  
 Palo in alluminio 90x65 mm  
 7 Stecche in alluminio 28x14 mm  
 Altezza ombrellone 280 cm  
 Telo UV80+  
 Basamento granito 125 kg 80x80x7 cm  
 In caso di condizioni avverse chiudere l'ombrellone per evitare danni alla struttura, a cose e persone.

Technical specifications:  
 Aluminium Pole 90x65 mm  
 No.7 aluminium ribs 28x14 mm  
 Parasol height 280 cm  
 UV80+ Canopy  
 Granite base 125 Kg 80x80x8 cm  
 In case of bad weather conditions, we strongly recommend to close the parasol in order to avoid damages to the structure, to objects and persons.





**Parasol**collection  
//Marte







# Parasolcollection

## //Marte

MARTE 3x3 / CODE: PARMAR



### Finishing

Aluminium frame



Waterproof fabric canopy



### Features



- 1-Telo 3x3 in tessuto da 250g in poliestere trattato in PU.
- 2-Optional: illuminazione a batteria ricaricabile.
- 3-Sistema di apertura retrattile che permette la chiusura parallela al palo. Sistema di apertura e chiusura del telo tramite manovella manuale removibile.
- 4-Basamento in cemento (90 kg) con ruote, di colore bianco o mokka in tinta alla struttura. Il palo girevole permette all'ombrellone di ruotare di 360°.
- 5-Optional: illuminazione con impianto audio per collegamento dispositivi Bluetooth.

- 1-Canopy 3x3 in 250g polyester with PU coating.
- 2-Optional: umbrella lights with rechargeable battery.
- 3-Retractable opening system allows umbrella closure parallel to the pole. Canopy opening/closure with removable hand crank.
- 4-Concrete base (90kg) with wheels, available in white or mokka colour. Turning pole allows parasol a 360° rotation.
- 5-Optional: umbrella Bluetooth speaker with led lights.

Specifiche:  
 Palo in alluminio 80x65 mm  
 7 Stecche in alluminio 28x14 mm  
 Altezza ombrellone 290 cm  
 Telo UV80+  
 Basamento in cemento 90 kg 70x70x8 cm  
 In caso di condizioni avverse chiudere l'ombrellone per evitare danni alla struttura, a cose e persone.

Technical specifications:  
 Aluminium Pole 80x65 mm  
 No.7 aluminium ribs 28x14 mm  
 Parasol height 290 cm  
 UV80+ Canopy  
 Concrete base 90 Kg70x70x8 cm  
 In case of bad weather conditions, we strongly recommend to close the parasol in order to avoid damages to the structure, to objects and persons.

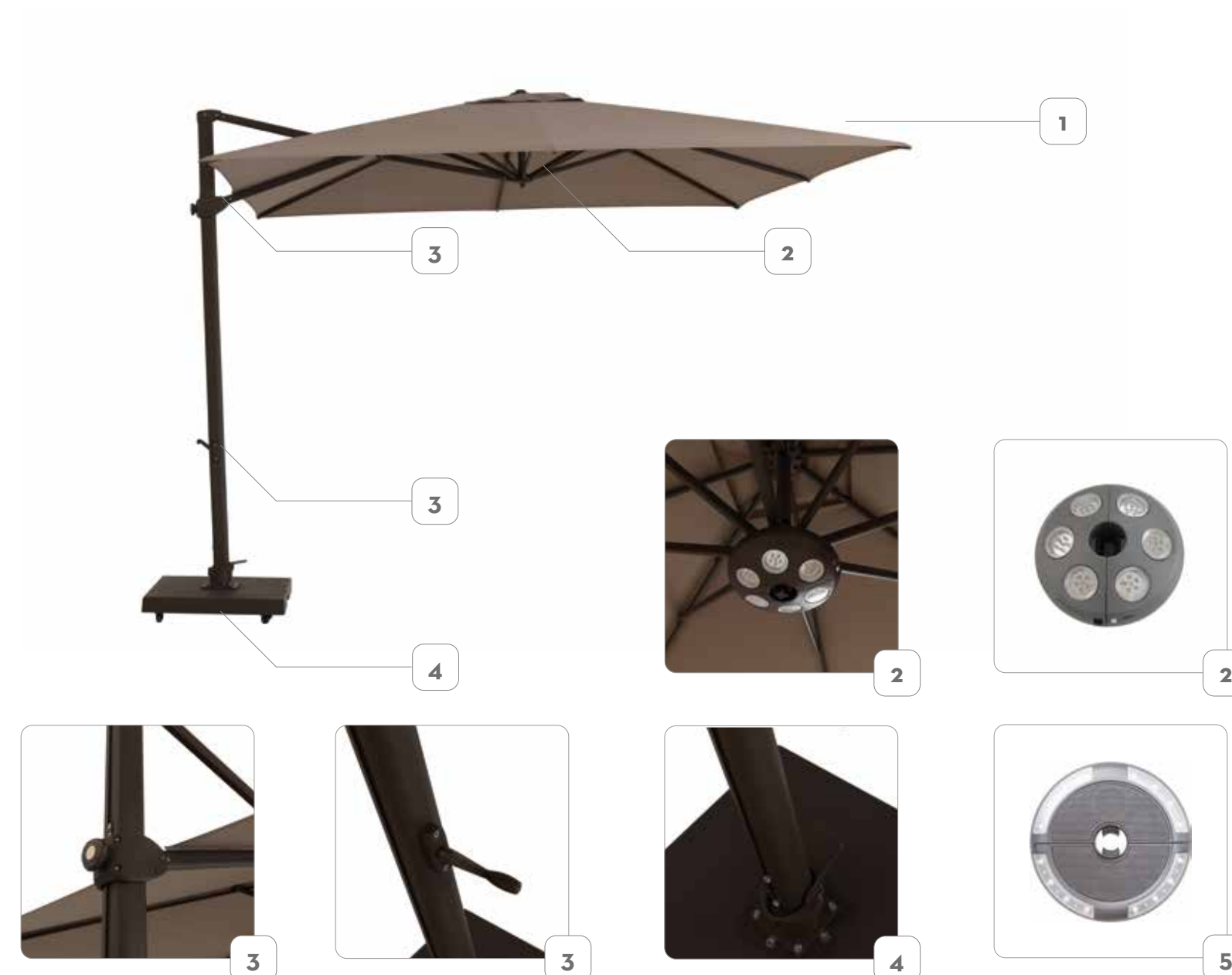



**Parasol**collection  
// Vulcano



# Parasolcollection

## // Vulcano

VULCANO 3x3 / CODE: PARVUL

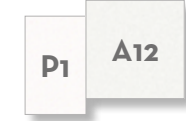

### Finishing

Aluminium frame

Waterproof fabric canopy

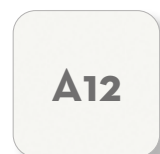

white



white

### Features

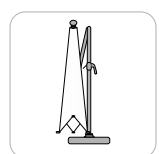
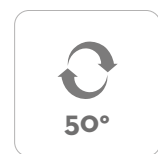

- 1-Telo 3x3 in tessuto da 250g in poliestere trattato in PU.
- 2-Optional: illuminazione a batteria ricaricabile.
- 3-Sistema di apertura retrattile che permette la chiusura parallela al palo.
- Sistema di apertura e chiusura del telo tramite manovella manuale removibile.
- Inclinabile fino a 50° su ambedue i lati.
- 4-Basamento con crociera in acciaio colore bianco. Per una stabilità ottimale si consiglia l'utilizzo di n.4 piastre in graniglia 50x50x4cm (pesi non inclusi).
- Il palo girevole permette all'ombrellone di ruotare di 360°.
- 5-Optional: illuminazione con impianto audio per collegamento dispositivi Bluetooth.

- 1-Canopy 3x3 in 250g polyester with PU coating.
- 2-Optional: umbrella lights with rechargeable battery.
- 3-Retractable opening system allows umbrella closure parallel to the pole.
- Canopy opening/closure with removable hand crank. Reclining up to 50° on both sides.
- 4-Steel white cross base with 4 grit plates. For a better stability we recommend you to use 4 grit plates 50x50x4cm (weights not included).
- Turning pole allows parasol a 360° rotation.
- 5-Optional: umbrella Bluetooth speaker with led lights.

Specifiche:  
 Palo in alluminio 80x60 mm  
 8 Stecche in alluminio 20x14 mm  
 Altezza ombrellone 280 cm  
 Telo UV80+  
 Basamento con 4 piastre in graniglia 50x50x4 cm (pesi non inclusi)  
 In caso di condizioni avverse chiudere l'ombrellone per evitare danni alla struttura, a cose e persone.

Technical specifications:  
 Aluminium Pole 80x60 mm  
 No.8 aluminium ribs 20x14 mm  
 Parasol height 280 cm  
 UV80+ Canopy  
 Base with 4 grit plates in size 50x50x4 cm (Weights not included)  
 In case of bad weather conditions, we strongly recommend to close the parasol in order to avoid damages to the structure, to objects and persons.





**Parasol**collection  
// Apollo





# Parasolcollection

## // Apollo

APOLLO 2x2 / CODE: PARAPO

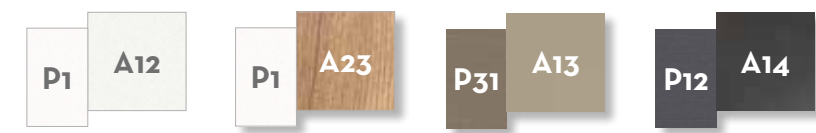

### Finishing

Aluminium frame

Waterproof fabric canopy



### Features

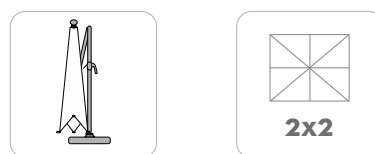

- 1 - Telo 2x2 in tessuto da 220g in poliestere trattato in PU.
- 2 - Sistema di apertura semplice ed intuitivo, spingere il tetto dell'ombrellone verso l'alto finché il meccanismo non si arresta.
- 3 - Puntale in alluminio cromato.
- 4 - Basamento in acciaio colore da 40 kg.

- 1 - Canopy 2x2 in 250g polyester with PU coating.
- 2 - Easily parasol opening: push upwards the parasol roof until it locks.
- 3 - Chrome-plated alu tip.
- 4 - Steel base 40 Kg.

Specifiche:  
 Palo in alluminio ø 38 mm  
 4 Stecche in alluminio ø 20 mm  
 Altezza ombrellone 245 cm  
 Telo UV80+  
 Basamento in acciaio 40 kg 50x50x2 cm  
 In caso di condizioni avverse chiudere l'ombrellone per evitare danni alla struttura, a cose e persone.

Technical specifications:  
 Aluminium pole diam. 38 mm  
 Parasol height 250 cm  
 No. 4 aluminium ribs diam. 20 mm  
 UV80+ Canopy  
 Steel base 40 Kg 50x50x2 cm  
 In case of bad weather conditions, we strongly recommend to close the parasol in order to avoid damages to the structure, to objects and persons.





**Carpet**collection  
// Nalu



# Carpet collection

## // Nalu

### Finishing

Fabric carpet



beige barré



grey barré



red barré



green barré

NALU 400x300 / CODE: TAPN1

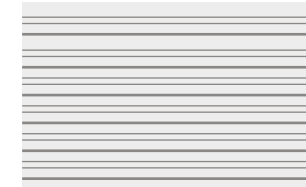

	Width	Depth
cm	400	300
inch	157,5	118,1

KG 35,0 | unit 1 0,32 mc |

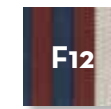

NALU 300x200 / CODE: TAPN2

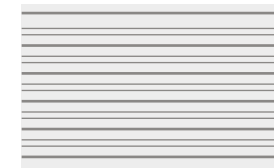

	Width	Depth
cm	300	200
inch	118,1	78,7

KG 18,0 | unit 1 0,27 mc |

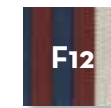
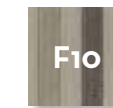



**Carpet**collection

// Quadro

// Ribs





// Ribs





// Quadro



// Quadro



# Carpet collection

// Quadro

// Ribs

## Finishing

Fabric carpet quadro



canvas



light grey



dark grey



red



dark green

Fabric carpet ribs



canvas



light grey



dark grey



dark green

QUADRO 400x300 / CODE: TAPQ3

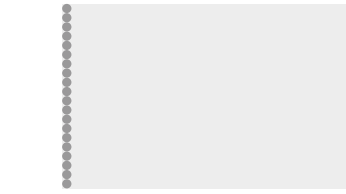

Width	Depth
cm 400	300
inch 157,5	118,1

KG 18,0 | unit 1 0,32 mc |

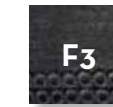

QUADRO 300x200 / CODE: TAPQ1

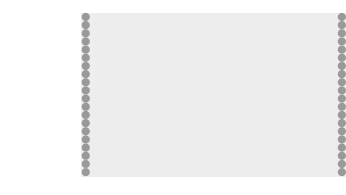

Width	Depth
cm 300	200
inch 118,1	78,7

KG 9,0 | unit 1 0,27 mc |

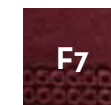
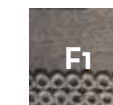

QUADRO 240x160 / CODE: TAPQ2

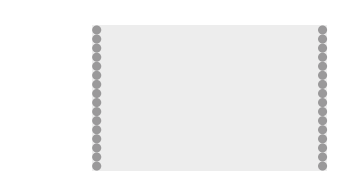

Width	Depth
cm 240	160
inch 94,5	63,0

KG 6,0 | unit 1 0,18 mc |

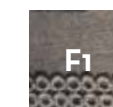

RIBS 400x300 / CODE: TAPR3



Width	Depth
cm 400	300
inch 157,5	118,1

KG 18,0 | unit 1 0,32 mc |

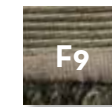
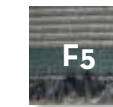
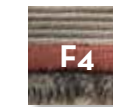

RIBS 300x200 / CODE: TAPR1



Width	Depth
cm 300	200
inch 118,1	78,7

KG 9,0 | unit 1 0,27 mc |

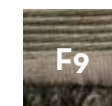
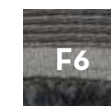
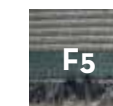
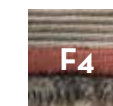

RIBS 240x160 / CODE: TAPR2



Width	Depth
cm 240	160
inch 94,5	63,0

KG 6,0 | unit 1 0,18 mc |

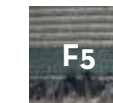

QUADRO DIAM 300 / CODE: TAPQ4

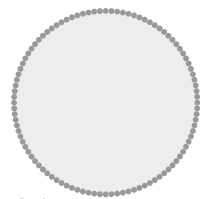

Width 300 | Depth 300  
cm  
inch 118,1 | 118,1

KG 11,0 | unit 1 0,32 mc |

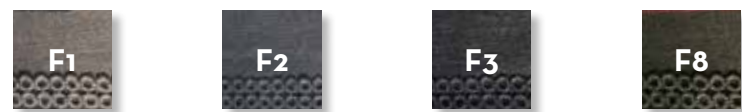

QUADRO DIAM 200 / CODE: TAPQ5

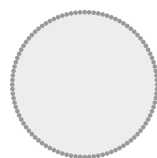

Width 200 | Depth 200  
cm  
inch 78,7 | 78,7

KG 5,0 | unit 1 0,27 mc |





**Casilda**collection  
// Lamps  
Design Ramón Esteve



# Casilda collection // Lamps

Design Ramón Esteve

## Finishing

Stainless steel frame



Accoya wood table top

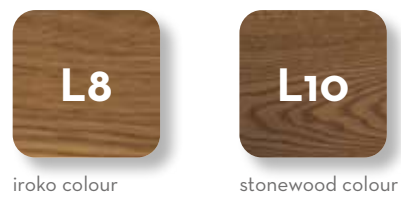

LAMP L / CODE: CASILAMPL



	Width	Depth	Height
cm	23	20	175
inch	9,1	7,9	68,9

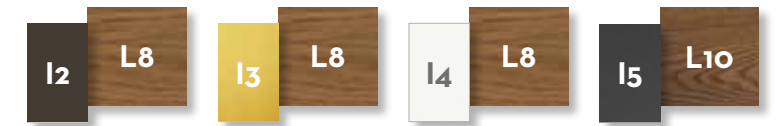

LAMP S / CODE: CASILAMPS



	Width	Depth	Height
cm	63	15	40
inch	24,8	5,9	15,7

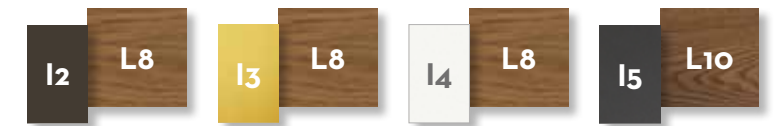

LAMP XS / CODE: CASILAMPXS



	Width	Depth	Height
cm	23	20	40
inch	9,1	7,9	15,7

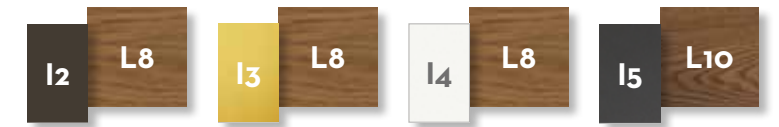
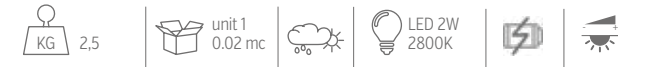



**Tribal**collection

// Lamps

Design Ludovica Serafini + Roberto Palomba

## Tribalcollection

small, medium & big lamp  
dove frame  
sand colour rope



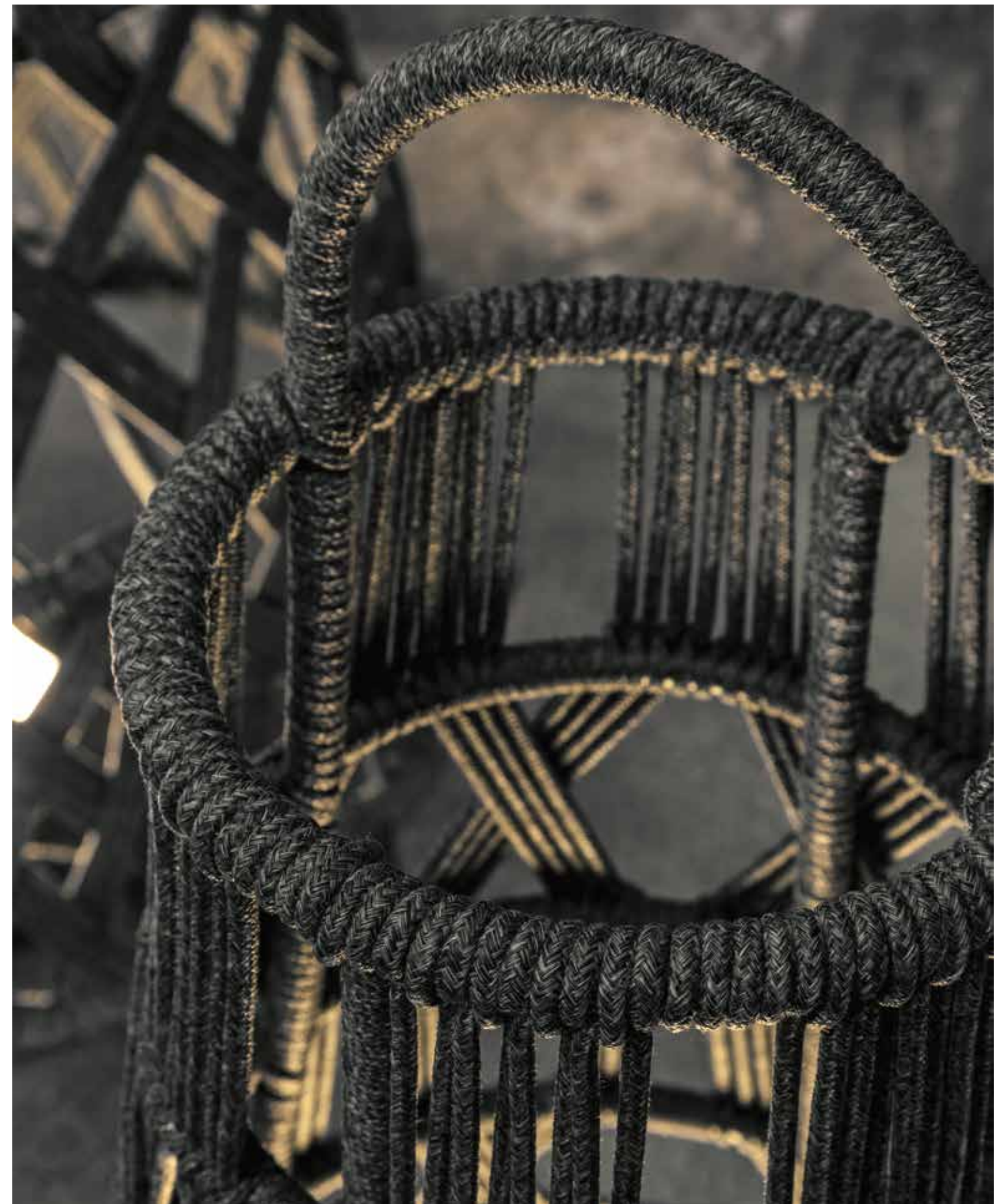

## Tribalcollection

small, medium & big lamp  
red frame  
red colour rope

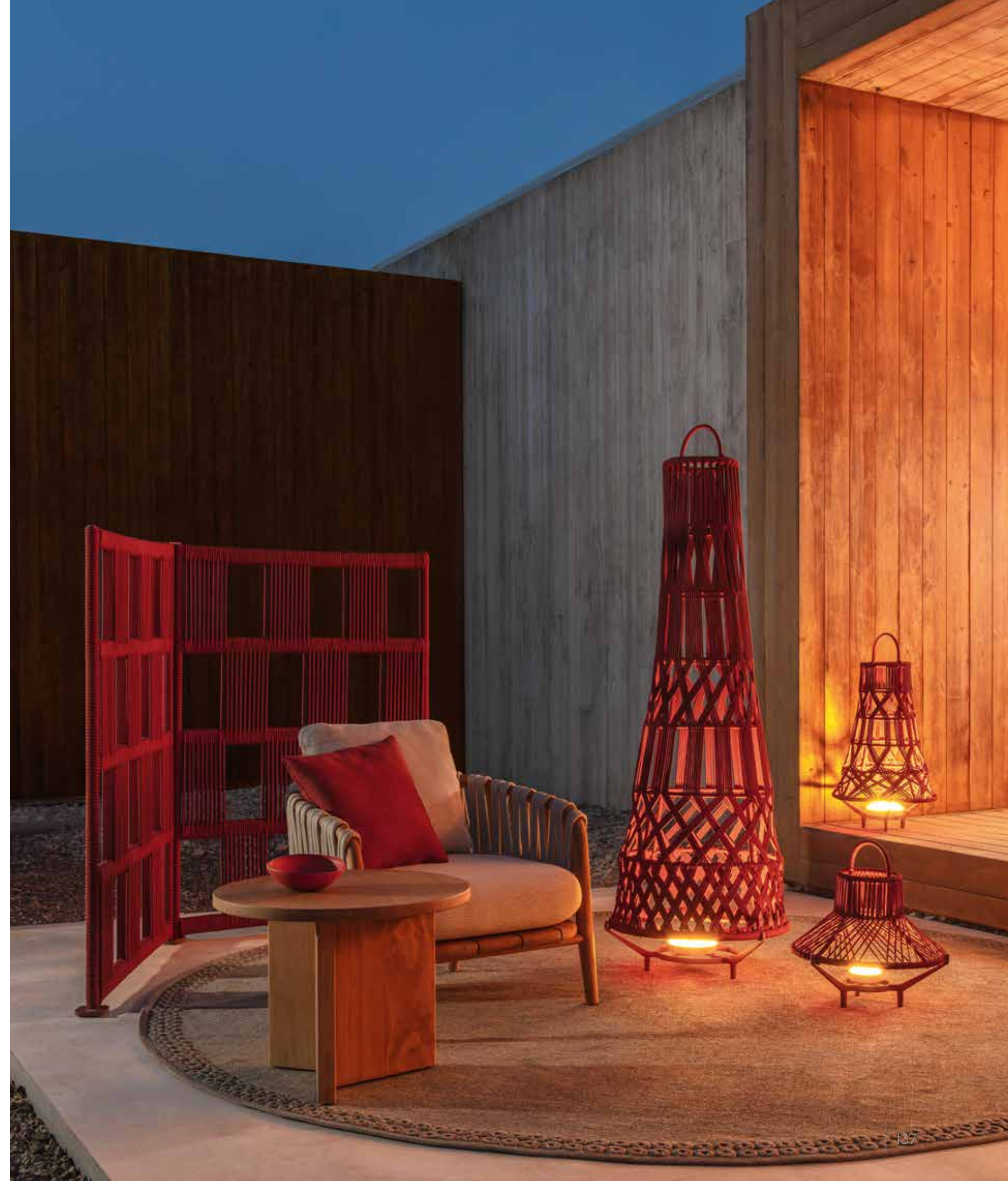



# Tribal collection // Lamps

Design Ludovica Serafini + Roberto Palomba

## Finishing

Aluminium frame



yellow



teal green



red



dove



graphite

Synthetic rope



dark grey



yellow



red



sand



teal green

TRIBAL BIG / CODE: TRIB01



	Width	Depth	Height
cm	60	60	175
inch	23,6	23,6	68,9



TRIBAL MEDIUM / CODE: TRIB02



	Width	Depth	Height
cm	45	45	85
inch	17,7	17,7	33,5



TRIBAL SMALL / CODE: TRIB03



	Width	Depth	Height
cm	45	45	45
inch	17,7	17,7	17,7



TRIBAL CELIN / CODE: TRIB04



	Width	Depth	Height
cm	45	45	71
inch	17,7	17,7	28,0





**Cleo**collection  
// Lamps  
Design Marco Acerbis







# Cleo collection // Lamps

## Design Marco Acerbis

### Finishing

Aluminium frame



white



graphite

Stainless steel frame



white

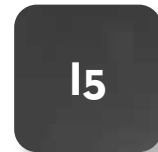

graphite



dove

LANTERN H66 / CODE: CLEL01



	Width	Depth	Height
cm	35	35	66
inch	13,8	13,8	26,0

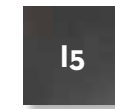

LANTERN H90 / CODE: CLEL02



	Width	Depth	Height
cm	40	40	90
inch	15,7	15,7	35,4

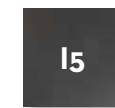

LANTERN H120 / CODE: CLEL03



	Width	Depth	Height
cm	45	45	120
inch	17,7	17,7	47,2

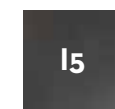

ARC LAMP / CODE: CLEALUL02



	Width	Depth	Height
cm	201	42	225
inch	79,1	16,5	88,6

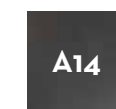
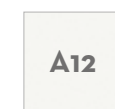



**Kukà**collection  
Design Studio Adolini





## Kukàcollection

medium & big lamp  
graphite and sand colour  
planter diam 40 cm in sand colour  
planter diam 60 cm in graphite colour





## Kukàcollection

small, medium & big lamp  
coffee table d50 & d80  
red colour



# Kukà collection

## Design Studio Adolini

### Finishing

Eco-resin for Lamp / Coffee Table

Cylindrical frame



Sand



Graphite



Red



Trasparent PMMA

Leather belt



brown

Cement for Planter



Sand



Graphite



Red

BIG LAMP / CODE: KUKL01



MEDIUM LAMP / CODE: KUKL02



SMALL LAMP / CODE: KUKL03

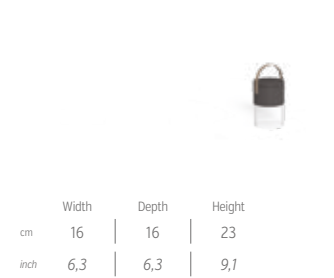

COFFEE TABLE D50 / CODE: KUKTC50



COFFEE TABLE D80 / CODE: KUKTC80



PLANTER D60 / CODE: KUKP60



	Width	Depth	Height
cm	60	60	60
inch	23,6	23,6	23,6



PLANTER D40 / CODE: KUKP40



	Width	Depth	Height
cm	40	40	70
inch	15,7	15,7	27,6





**Malè**collection

// Lamps

Design Ludovica Serafini + Roberto Palomba





## Malécollection

small & big lamp  
white colour

## Malécollection

small & big lamp  
dove & graphite colour



# Malè collection // Lamps

Design Ludovica Serafini + Roberto Palomba

## Finishing

Stainless steel frame



white



graphite



dove

Translucent polyethylene



white



dove



graphite

LAMP H190 / CODE: MALL190



	Width	Depth	Height
cm	52	52	190
inch	20,5	20,5	74,8

23,0 KG | 
 unit 1 0,60 mc | 
 | 
 E27 40W LED 98W | 
 220V |

I4 | 
 PE1t | 
 I6 | 
 PE2t | 
 I5 | 
 PE3t

LAMP H90 / CODE: MALL90



	Width	Depth	Height
cm	52	52	90
inch	20,5	20,5	35,4

15,0 KG | 
 unit 1 0,26 mc | 
 | 
 E27 40W LED 48W | 
 220V |

I4 | 
 PE1t | 
 I6 | 
 PE2t | 
 I5 | 
 PE3t



**Tod**collection  
// Lamps  
Design Marco Acerbis



# Tod collection // Lamps

## Design Marco Acerbis

LAMP / CODE: TODLAMP



	Width	Depth	Height
cm	90	90	240
inch	35.4	35.4	94.4

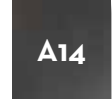
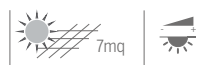
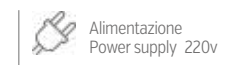

### Finishing

Aluminium frame



white



graphite



**Dolce**vitacollection



# Dolcevitacollection

## Design Studio Talenti

### Finishing

Wood frame



natural teak



teak silver-grey colour

Synthetic ropes



beige

LANTERN SMALL / CODE: DOLLAMP01



	Width	Depth	Height
cm	26	26	40
inch	10.2	10.2	15.7



LANTERN BIG / CODE: DOLLAMP02



	Width	Depth	Height
cm	26	26	60
inch	10.2	10.2	23.6

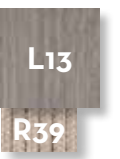



**Coral**collection

// Lamps

Design Marco Acerbis



## Coralcollection

small, medium & big lamp  
rope in graphite colour  
graphite colour frame



# Coral collection // Lamps

## Design Marco Acerbis

### Finishing

Aluminium frame



white



graphite

Synthetic ropes

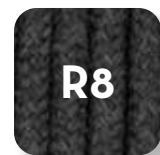

dark grey



beige

Wood



teak

LAMP H125/ CODE: CORL01



	Width	Depth	Height
cm	28	28	125
inch	11,0	11,0	49,2

9,5 KG | 
 unit 1 0,14 mc | 
 | 
 LED 7W 2800K | 
 |

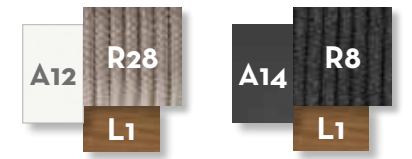

LAMP H95/ CODE: CORL02



	Width	Depth	Height
cm	28	28	95
inch	11,0	11,0	37,4

8,5 KG | 
 unit 1 0,11 mc | 
 | 
 LED 7W 2800K | 
 |

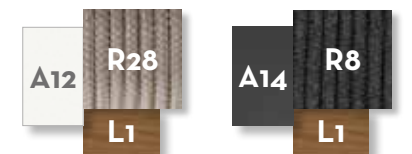

LAMP H45/ CODE: CORL03



	Width	Depth	Height
cm	28	28	45
inch	11,0	11,0	17,7

6,0 KG | 
 unit 1 0,04 mc | 
 | 
 LED 3,5W 2800K | 
 |

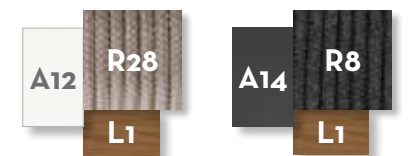



**Toffee**collection  
// Lamps





# Toffee collection // Lamps

Design Studio Talenti

## Finishing

Aluminium frame



white

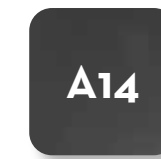

graphite

TOFEE / CODE: TOF01

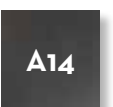

	Width	Depth	Height
cm	11	11	19
inch	4,3	4,3	7,5



**Swan**collection  
// Lamps





# Swan collection

## // Lamps

### Finishing

Glossy fiberglass



glossy dove



glossy cinnamon



glossy orange

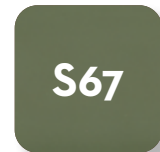

glossy green

LAMP S / CODE: SWAL01



	Width	Depth	Height
cm	27	16	40
inch	10.6	6.3	15.7

4,0 | 
 unit 1 0,02 mc | 
 | 
 LED 3,5W 2800K | 
 |

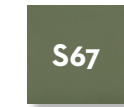
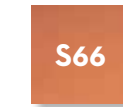
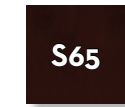
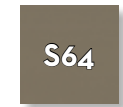

LAMP L / CODE: SWAL02



	Width	Depth	Height
cm	30	20	110
inch	11.8	7.9	43.3

17,0 | 
 unit 1 0,07 mc | 
 | 
 LED 3,5W 2800K | 
 |

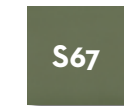
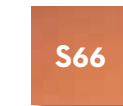
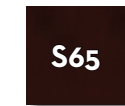
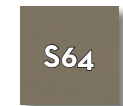



**Snap**collection

Design Favaretto & Partners





# Snapcollection

Design Favaretto & Partners

## Finishing

Glossy fiberglass



glossy beige

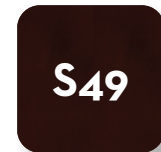

glossy brown

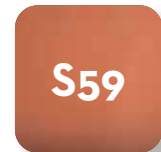

glossy nut

Cushions fabric



inkas grey

POUF / CODE: SNAPUF



	Width	Depth	Height
cm	40	40	44
inch	15.7	15.7	17.3

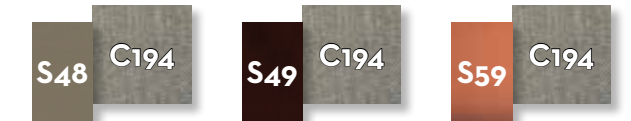

COFFEE TABLE 40X40 / CODE: SNATC40



	Width	Depth	Height
cm	40	40	55
inch	15.7	15.7	21.7

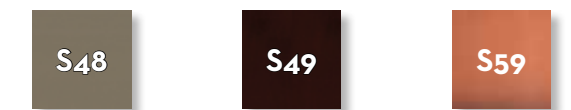

COFFEE TABLE 50X50 / CODE: SNATC50



	Width	Depth	Height
cm	50	50	45
inch	19.7	19.7	17.7

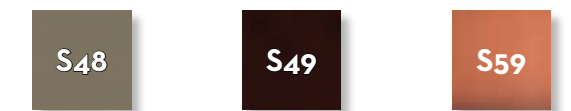

COFFEE TABLE 70X70 / CODE: SNATC70



	Width	Depth	Height
cm	70	70	35
inch	27.6	27.6	13.8

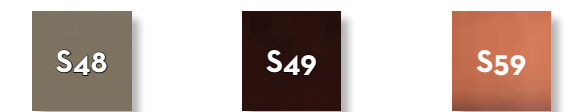



**Plaza**collection  
Design Marco Acerbis





## Plazacollection

coffee table d45 & coffee table 80x65  
grey cement colour



# Plazacollection

## Design Marco Acerbis

### Finishing

Concrete table top



beige cement



grey cement



blue cement

Plaza coffee table glossy fiberglass



glossy beige

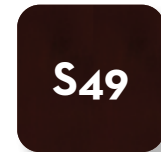

glossy brown

PLAZA COFFEE TABLE D45 / CODE: PLATC45



	Width	Depth	Height
cm	45	45	48
inch	17.7	17.7	18.9

KG 23,0 | unit 1 0.17 mc |

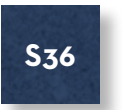

PLAZA COFFEE TABLE 80X65 / CODE: PLATC8065



	Width	Depth	Height
cm	80	65	35
inch	31.5	25.6	13.8

KG 45,0 | unit 1 0.30 mc |

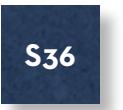

PLAZA GLOSSY COFFEE TABLE D45 / CODE: PLATC45G



	Width	Depth	Height
cm	45	45	48
inch	17.7	17.7	18.9

KG 12,0 | unit 1 0.17 mc |

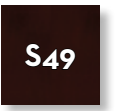
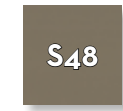

PLAZA GLOSSY COFFEE TABLE 80X65 / CODE: PLATC8065G



	Width	Depth	Height
cm	80	65	35
inch	31.5	25.6	13.8

KG 23,0 | unit 1 0.30 mc |

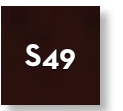
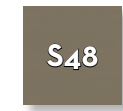



**Parker**collection

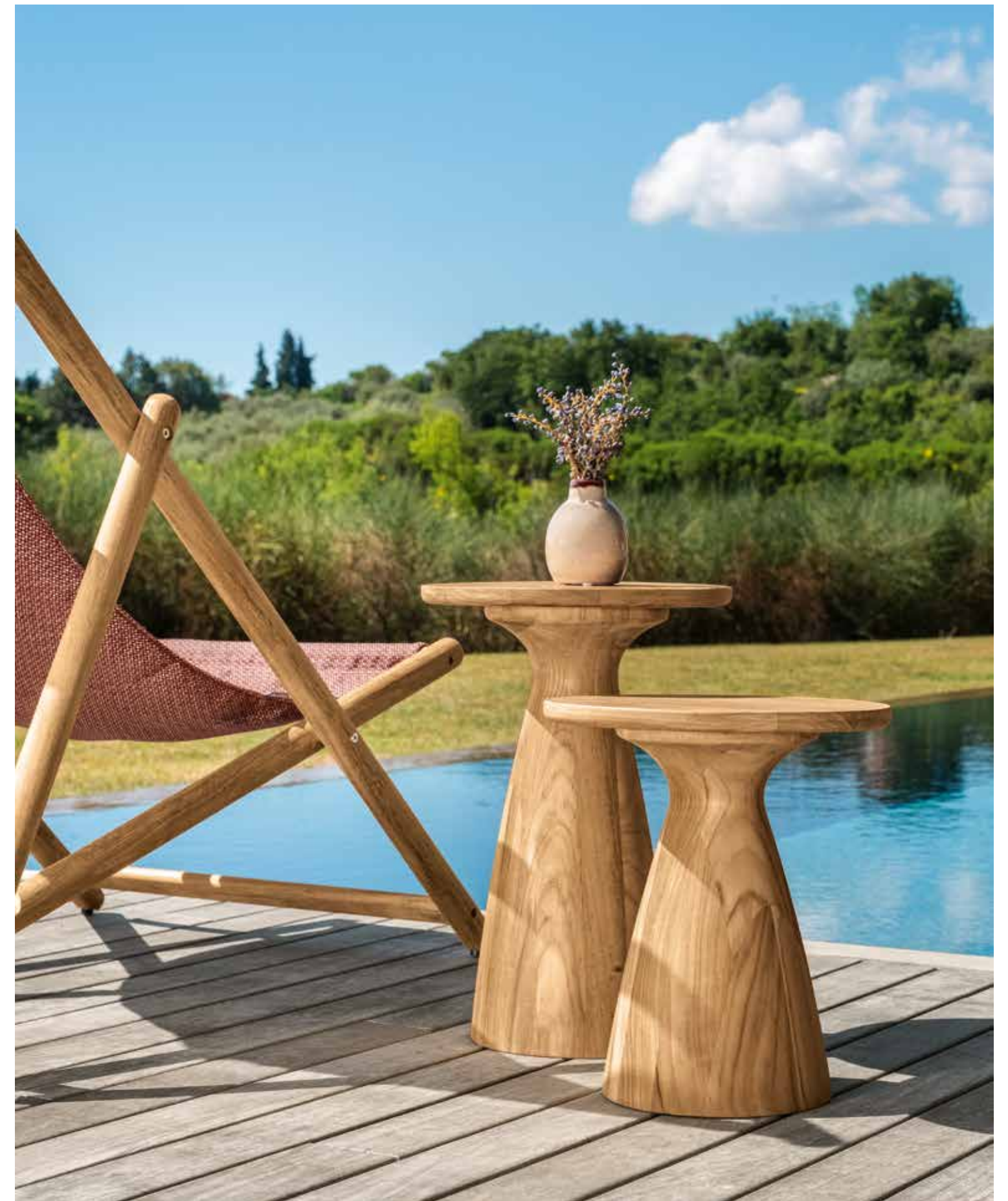

# Parker collection

## Design Studio Talenti

### Finishing

Wood frame



natural teak



teak silver-grey colour

COFFEE TABLE H35 / CODE: PARTL35



	Width	Depth	Height
cm	30	30	35
inch	11.8	11.8	13.8

5,0 KG | 
 unit 1 0,07 mc |

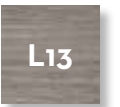

COFFEE TABLE H45 / CODE: PARTL45



	Width	Depth	Height
cm	30	30	45
inch	11.8	11.8	17.7

9,0 KG | 
 unit 1 0,09 mc |

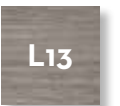
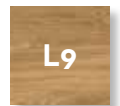



**Gabri**collection  
Design Studio Talenti



# Gabri collection

## Design Studio Talenti

### Finishing

Terrazzo table top



beige



grey



red

COFFEE TABLE H45 / CODE: GABTL45



	Width	Depth	Height
cm	40	40	45
inch	15,7	15,7	17,7

KG 11,0 | unit 1 0,10 mc

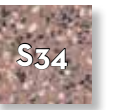

COFFEE TABLE H55 / CODE: GABTL55



	Width	Depth	Height
cm	40	40	55
inch	15,7	15,7	21,7

KG 12,0 | unit 1 0,12 mc

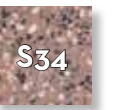



**Sylvie**collection



# Sylvie collection

## Design Studio Talenti

COFFEE TABLE / CODE: SYLTL55

KG 4,0 | unit 1 0,20 mc | ☀️



	Width	Depth	Height
cm	47	59	55
inch	18.5	23.2	21.7

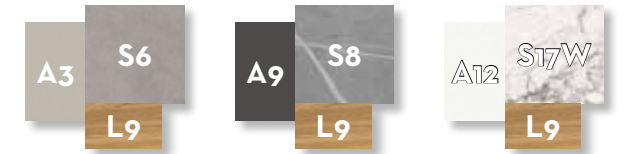

### Finishing

Aluminium frame



warm white



charcoal



white

Gres table top



warm grey



grey



calacatta

Wood table top



natural teak



**Musa**collection  
Design Studio Adolini



## Musacollection

planter D 90 in terracotta colour  
planter D 60 in grey colour  
planter D 50 in warm grey colour



# Musacollection

## Design Studio Adolini

### Finishing

Fiber cement



warm grey



grey



terracotta

PLANTER H60 / CODE: MUSP60



	Width	Depth	Height
cm	60	60	60
inch	23.6	23.6	23.6

40,0 | 
 unit 1 0.34 mc | 
 |



PLANTER H70 / CODE: MUSP70



	Width	Depth	Height
cm	50	50	70
inch	17.7	17.7	27.5

40,0 | 
 unit 1 0.28 mc | 
 |



PLANTER H30 / CODE: MUSP30



	Width	Depth	Height
cm	90	90	30
inch	35.4	35.4	11.8

60,0 | 
 unit 1 0.51 mc | 
 |





**Jackie**collection





## Jackiecollection

small, medium & big pouf  
rope in dark grey colour













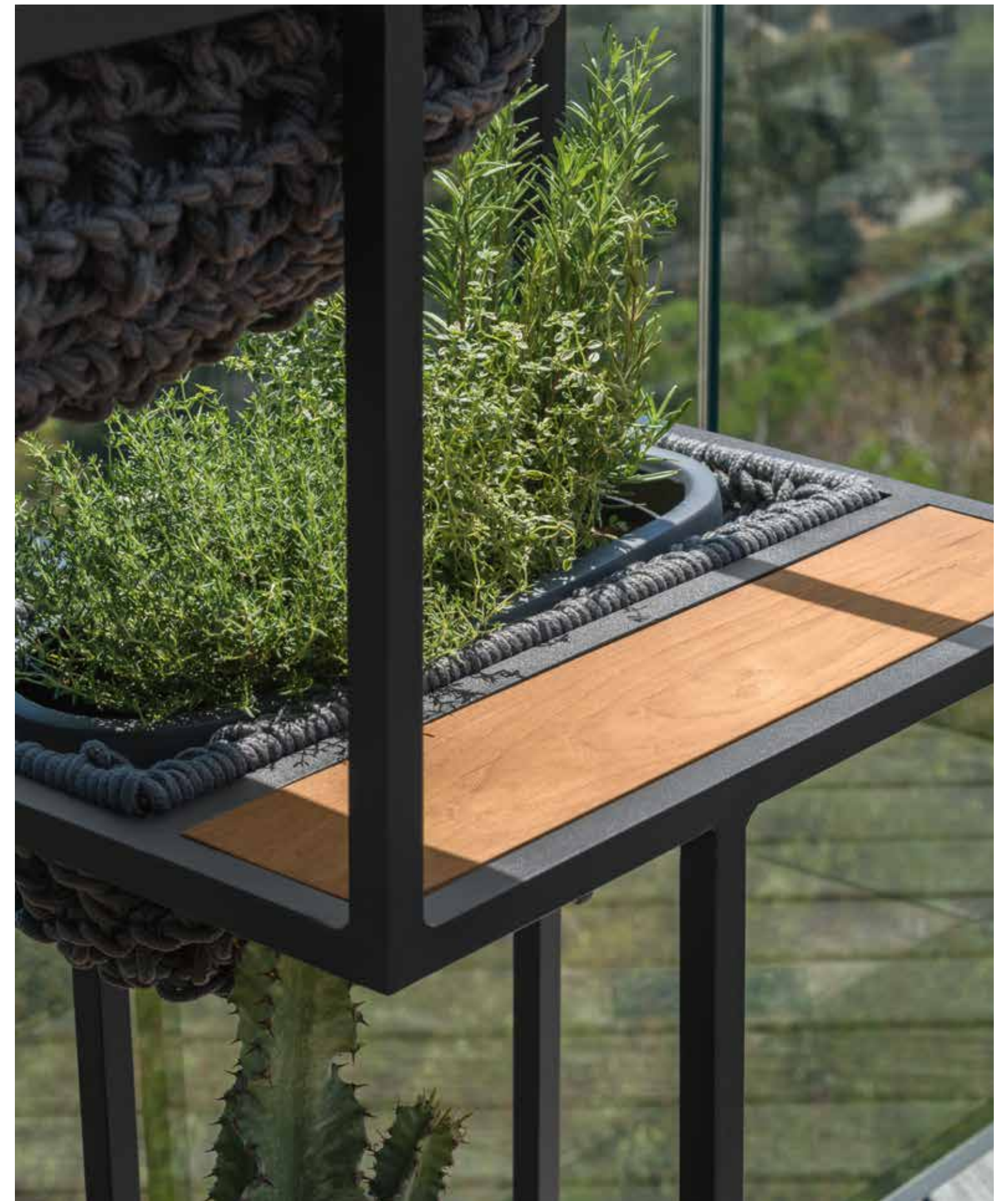

## Jackiecollection

planter  
white colour  
rope in light grey colour

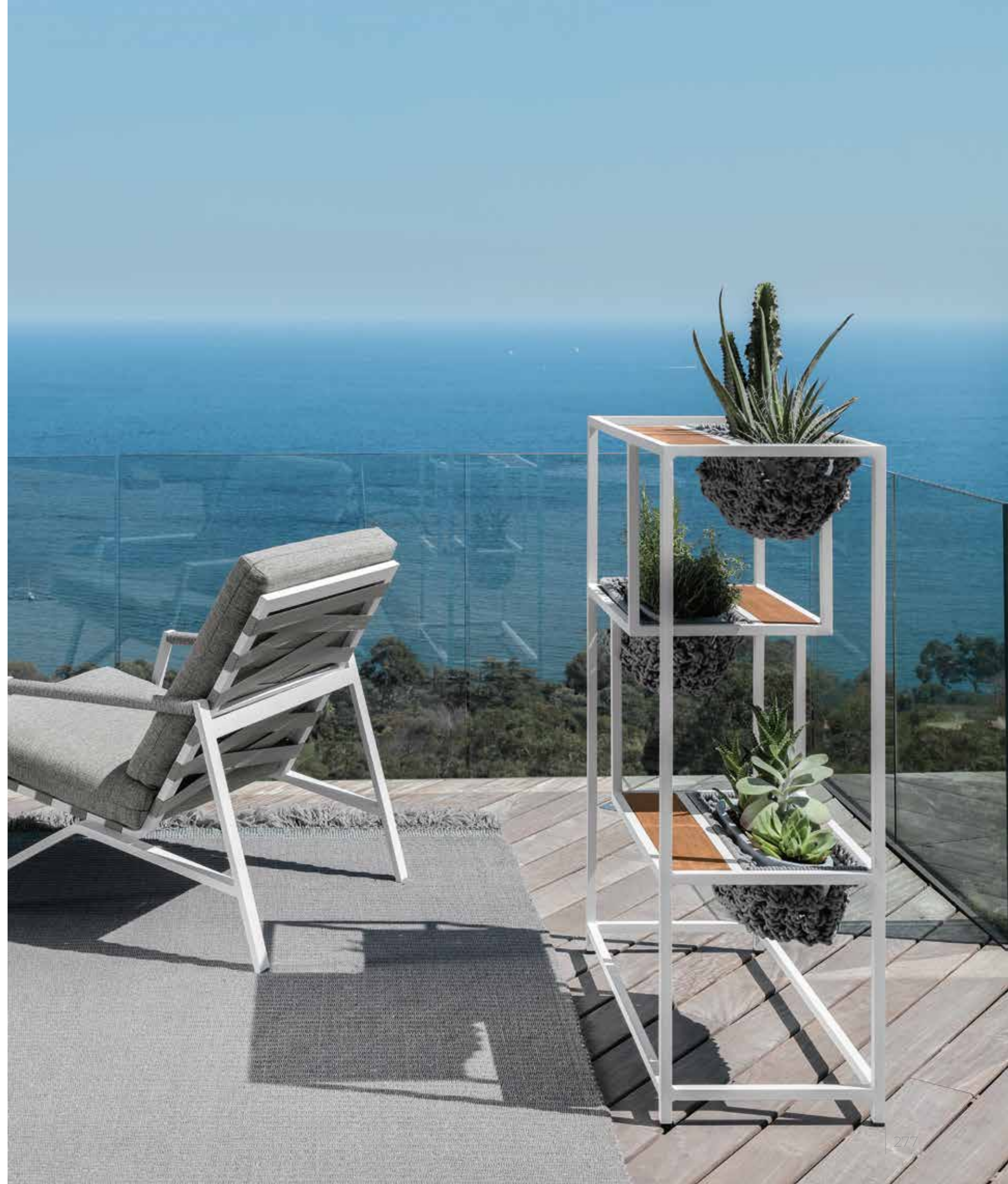

# Jackiecollection

## Design Studio Talenti

### Finishing

Aluminium frame



white



graphite

Steel frame



white



graphite

Synthetic ropes



dove



light grey



dark grey



hunter green

Wood slats



teak

BEAN BAG / CODE: JACBAG



	Width	Depth	Height
cm	167	117	62
inch	65,7	46,1	24,4

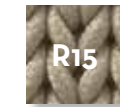

LIVING ARMCHAIR / CODE: JACPL



	Width	Depth	Height	H.arm	H.seat
cm	78	80	73	57	35
inch	30,7	31,5	28,7	22,4	13,8

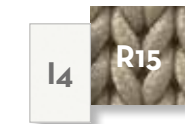

POUF SMALL / CODE: JACPUFP



	Width	Depth	Height
cm	56	56	26
inch	22,0	22,0	10,2



POUF MEDIUM / CODE: JACPUFM



	Width	Depth	Height
cm	64	64	32
inch	25,2	25,2	12,6



POUF BIG / CODE: JACPUFG



	Width	Depth	Height
cm	83	83	38
inch	32,7	32,7	15,0



BASKET / CODE: JACBAK

KG 4,0 | unit 1 0,11 mc | ☁️



	Width	Depth	Height
cm	55	55	30
inch	21,7	21,7	11,8

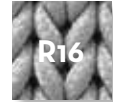

PLANTER / CODE: JACPLAN

KG 17,0 | unit 1 0,48 mc | ☁️



	Width	Depth	Height
cm	90	40	120
inch	35,4	15,7	47,2

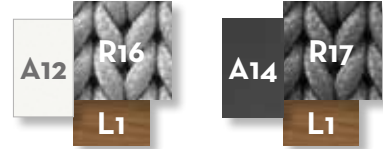



**Scacco**collection

// Partition

Design Ludovica Serafini + Roberto Palomba



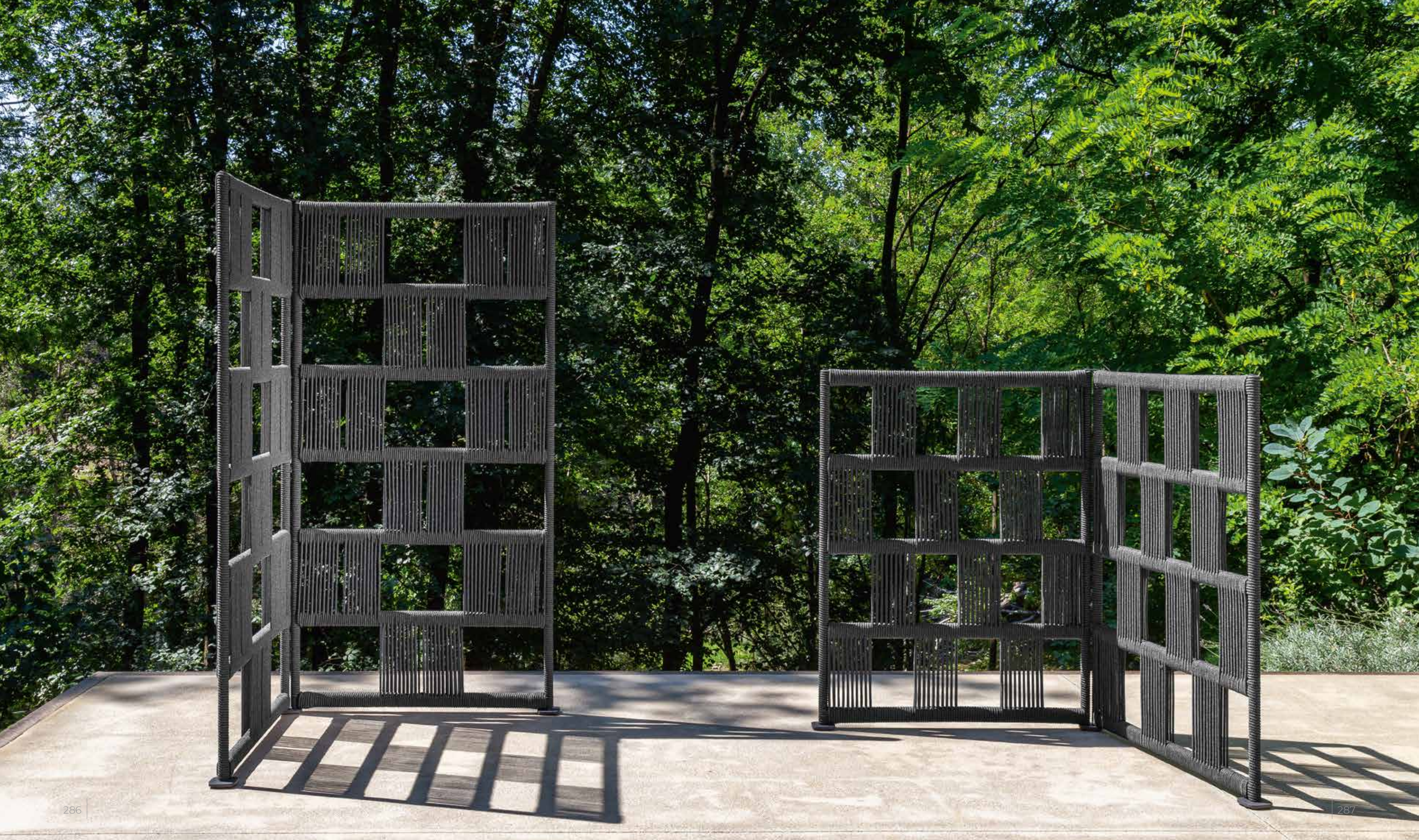



# Scaccocollection

## // Partition

### Finishing

Aluminium frame



graphite



beige



red

Syntetic rope



beige



dark grey



red

PARTITION H135 / CODE: SCAPAR135



	Width	Depth	Height
cm	100	5	135
inch	39,4	2,0	53,1



PARTITION H200 / CODE: SCAPAR200

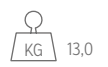

	Width	Depth	Height
cm	100	5	200
inch	39,4	2,0	78,7





**Chora**collection  
Design Mariateresa Casarola

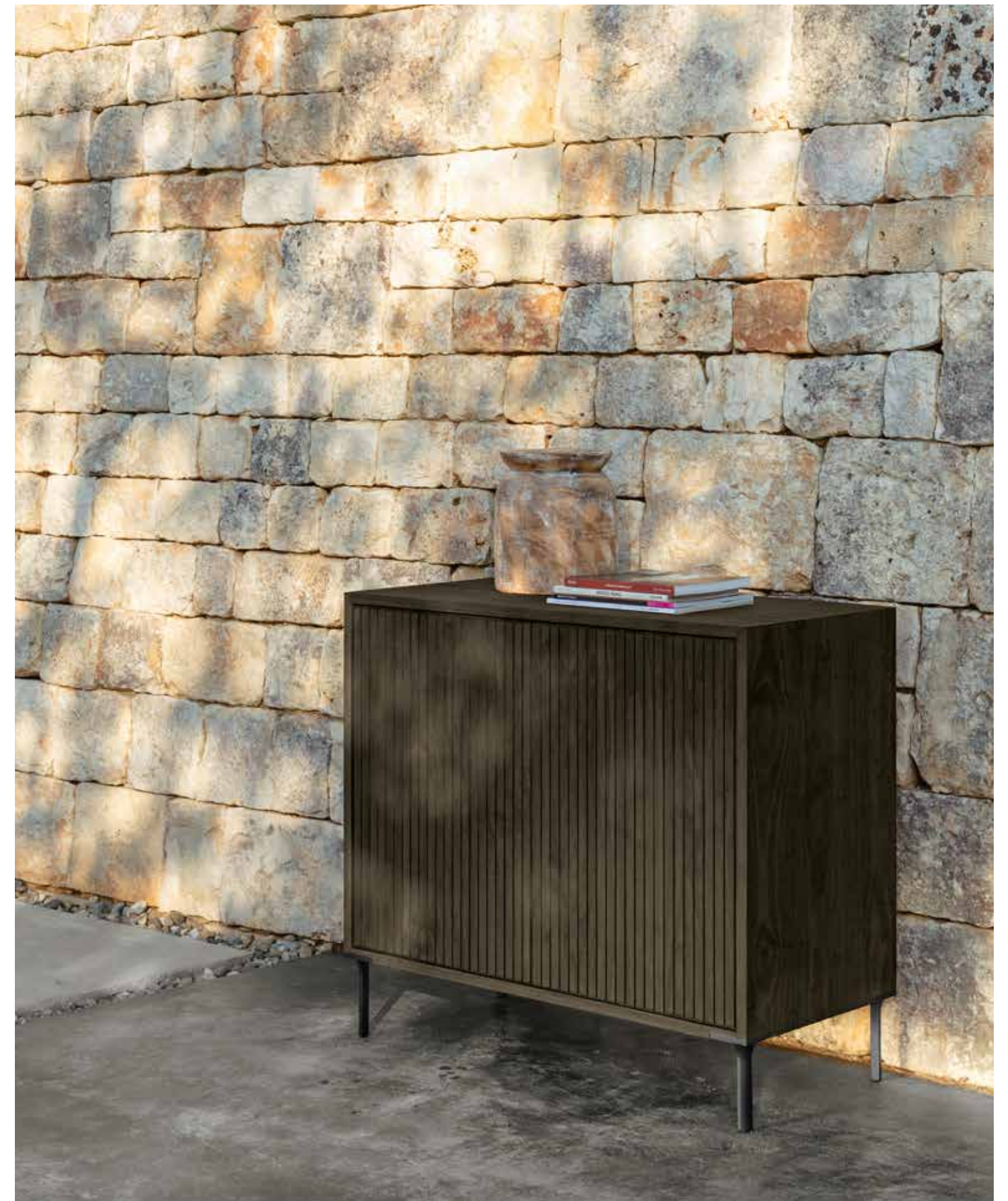

## Choracollection

madia 97x45  
accoya wood frame in natural teak colour







# Chora collection

## Design Mariateresa Casarola

### Finishing

Accoya wood frame



palissandro colour



natural teak colour

Aluminium legs



graphite

MADIA 97x45 / CODE: CHOMAD1



	Width	Depth	Height
cm	97	45	85
inch	38.2	17.7	33.4

40,0 | 
 unit 1 0.45 mc | 
 8% |



MADIA 192x45 / CODE: CHOMAD2



	Width	Depth	Height
cm	192	45	85
inch	75.6	17.7	33.4

80,0 | 
 unit 1 0.88mc | 
 8% |



MOBILE 75x45 / CODE: CHOMAD3



	Width	Depth	Height
cm	75	45	180
inch	29.5	17.7	70.8

80,0 | 
 unit 1 0.74 mc | 
 8% |

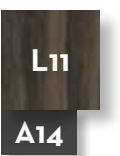



**Tikal**collection  
Design Nicola de Pellegrini





Finishing

Metal frame

Doors frame



magnesit black



magnesit white



accoya wood natural teak colour

KITCHEN CHEST / CODE: TIKMAD

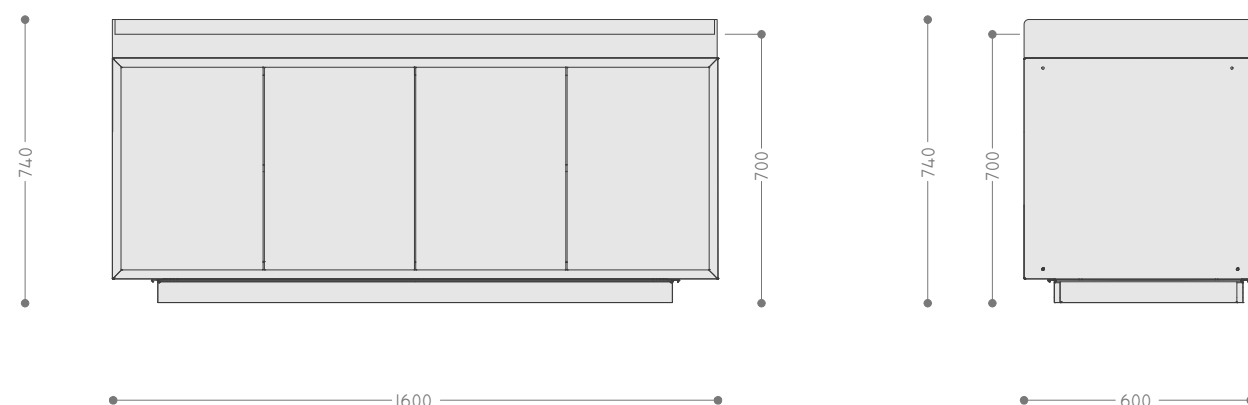
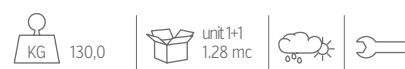

Madia

Struttura in acciaio zinco magnesio e alluminio (Magnesit), verniciatura bianco RAL 9003 o nero RAL 9004 alte temperature testurizzato.

4 ante a battente disponibili o in magnesit o in legno di accoya tinto natural teak con maniglia ad incasso gola, apertura 125° a sgancio rapido e chiusura blumotion. Top in gres.  
Misure 1600x600x740 h - peso 130 kg.  
Dimensioni interne del vano 65x54x49 h

Kitchen chest

Structure in zinc magnesium steel and aluminium (Magnesit), white RAL 9003 or black RAL 9004 high temperature, textured painting. 4 swing doors available in magnesit or in accoya wood, natural teak colored with recessed handles, fast release 125° opening and blumotion latch. Gres top.  
Dimensions: 1600x600x740 h - weight 130 kg.  
Internal dimensions of the compartment 65x54x49 h

SHELF MODULE 120X190 / CODE: TIKSCA120

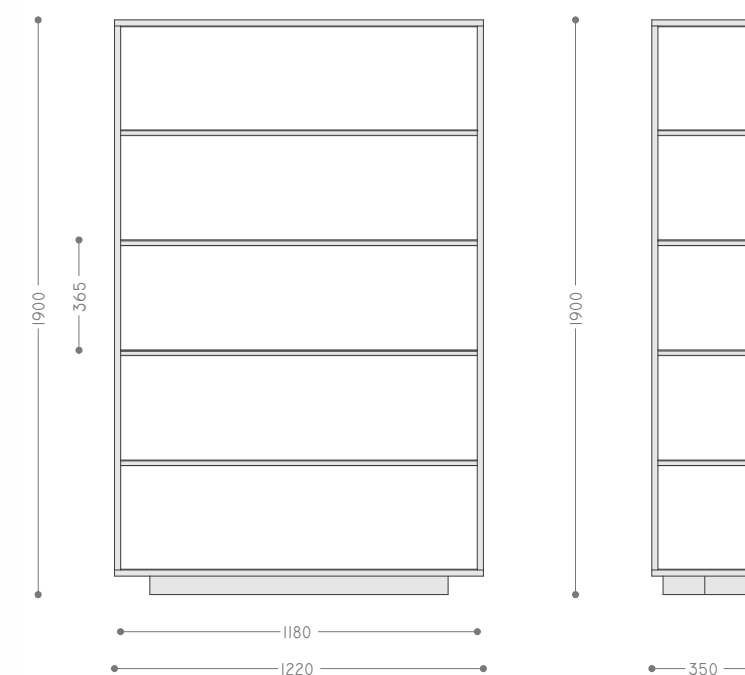

Modulo scaffale 120x190

Struttura in acciaio zinco magnesio e alluminio (Magnesit), verniciatura bianco RAL 9003 o nero RAL 9004 alte temperature testurizzato.  
Scaffale con mensole metalliche removibili e regolabili.  
Misure 1220x1900x350 - peso 50 kg

Shelf module 120x190

Structure in zinc magnesium steel and aluminium (Magnesit), white RAL 9003 or black RAL 9004 high temperature, textured painting.  
Shelf with removable and adjustable metal shelves.  
Dimensions 1220x1900x350 - weight 50 kg

SUSPENDED CABINET WITH FLAP DOOR 118X36 / CODE: TIKSCA120M



Pensile con anta a ribalta 118x36

Struttura in acciaio zinco magnesio e alluminio (Magnesit), verniciatura bianco RAL 9003 o nero RAL 9004 alte temperature testurizzato.  
Anta a ribalta con maniglia ad incasso gola, apertura 107° e chiusura blumotion. Misure 1180x365x350 - peso 20 kg  
\*abbinabile solo al modulo scaffale 120x190

Suspended cabinet with flap door 118x36

Structure in zinc magnesium steel and aluminium (Magnesit), white RAL 9003 or black RAL 9004 high temperature, textured painting.  
Flap door with recessed handles, 107° opening and blumotion latch. Dimensions 1180x365x350 - weight 20 kg  
\*only compatible with shelf module 120x190

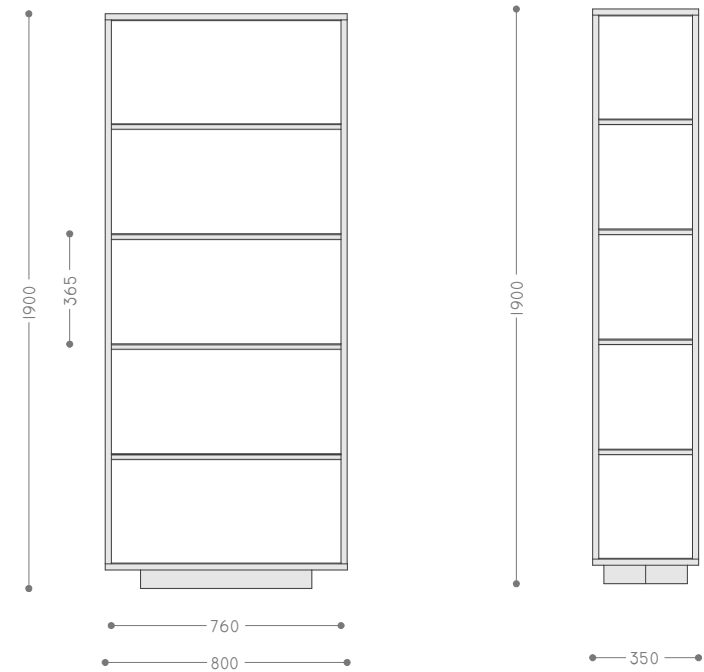

Modulo scaffale 80x190

Struttura in acciaio zinco magnesio e alluminio (Magnesit), verniciatura bianco o nero RAL 9004 alte temperature testurizzato. Scaffale con mensole metalliche removibili e regolabili. Misure 800x1900x350 - peso 40 kg

Shelf module 80x190

Structure in zinc magnesium steel and aluminium (Magnesit), white or black RAL 9004 high temperature, textured painting. Shelf with removable and adjustable metal shelves. Dimensions: 800x1900x350 - weight 40 kg

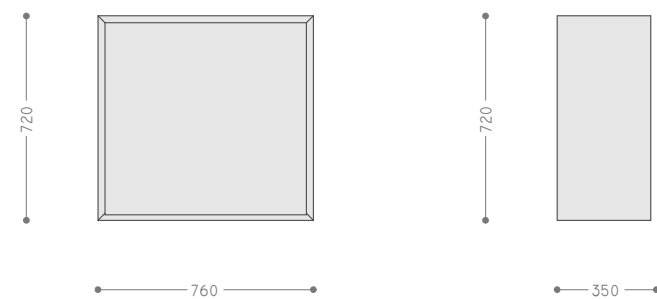

Mobile base 76x72

Struttura in acciaio zinco magnesio e alluminio (Magnesit), verniciatura bianco o nero RAL 9004 alte temperature testurizzato. Anta a battente con maniglia ad incasso gola, apertura 125° a sgancio rapido e chiusura blumotion. Misure 760x700x350 - peso 25 kg  
\*abbinabile solo al modulo scaffale 80x190

Cabinet base 76x72

Structure in zinc magnesium steel and aluminium (Magnesit), white or black RAL 9004 high temperature, textured painting. Swing door with recessed handles, fast release 125° opening and blumotion latch. Dimensions 760x700x350 - weight 25 kg  
\*only compatible with shelf module 80x190





**Showergate**collection  
Design Marco Acerbis



# Showergate collection

Design Marco Acerbis

SHOWER GATE / CODE: DCCG01



	Width	Depth	Height
cm	90	100	220
inch	35,4	39,4	86,6

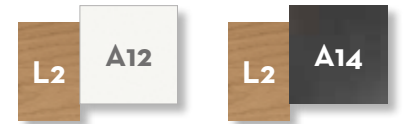

## Finishing

Alluminium frame



white



graphite

Wood base



accoya natural teak colour



**Path**collection

// Planter

Design Filippo Cagnotto



## Pathcollection

planter h85 / h100 / h120  
graphite colour frame



# Path collection // Planter

## Design Filippo Cagnotto

### Finishing

Stainless steel frame



white



graphite

PLANTER H85 / CODE: PAT85

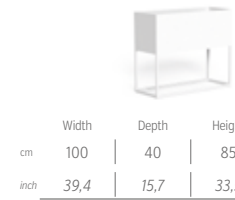
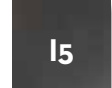

PLANTER H100 / CODE: PAT100

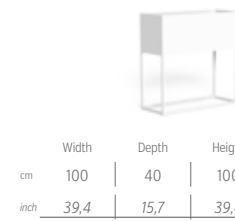
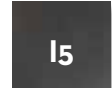
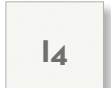

PLANTER H120 / CODE: PAT120

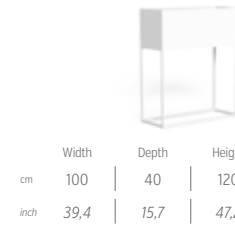
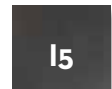
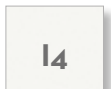

PLANTER+HANDRAIL H85/ CODE: PAT85H

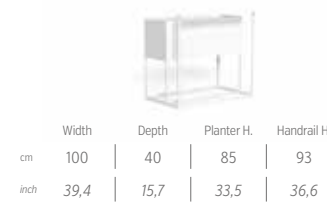
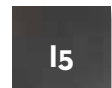
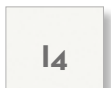

PLANTER+HANDRAIL H100/ CODE: PAT100H

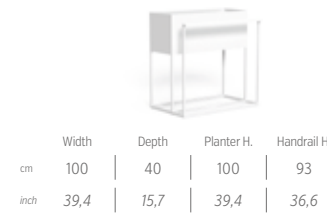
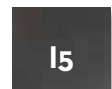
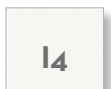

PLANTER+HANDRAIL H120/ CODE: PAT120H

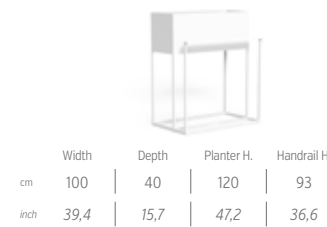
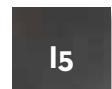
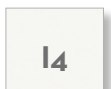



## **Cart**collection







# Cart collection

## Design Studio Talenti

### Finishing

Aluminium frame



white



dove



graphite

Wood slats



teak

CART / CODE: ACCCAR



	Width	Depth	Height	H.whe
cm	90	55	76	22
inch	35,4	21,7	29,9	8,7

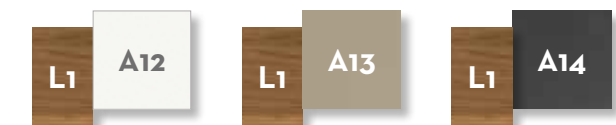



**Ray**collection





# Raycollection

## Design Studio Talenti

Aluminium frame



charcoal



graphite



dove

SMALL SERVING TABLE / CODE: RAYVP



	Width	Depth	Height
cm	60	60	45
inch	23,6	23,6	17,7

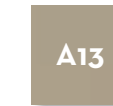
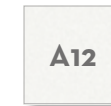
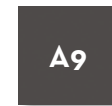

BIG SERVING TABLE / CODE: RAYVG



	Width	Depth	Height
cm	60	60	73
inch	23,6	23,6	28,7





**Box**collection





# Accessories collection

// Box

## Finishing

Aluminium frame



white



dove

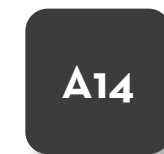

graphite

Textilene covering



white

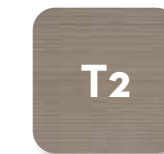

dove



silver black

BOX / CODE: BOXAL01



	Width	Depth	Height
cm	131	62	56
inch	51.6	24.4	22.0



# Materials

Alluminio / Aluminium

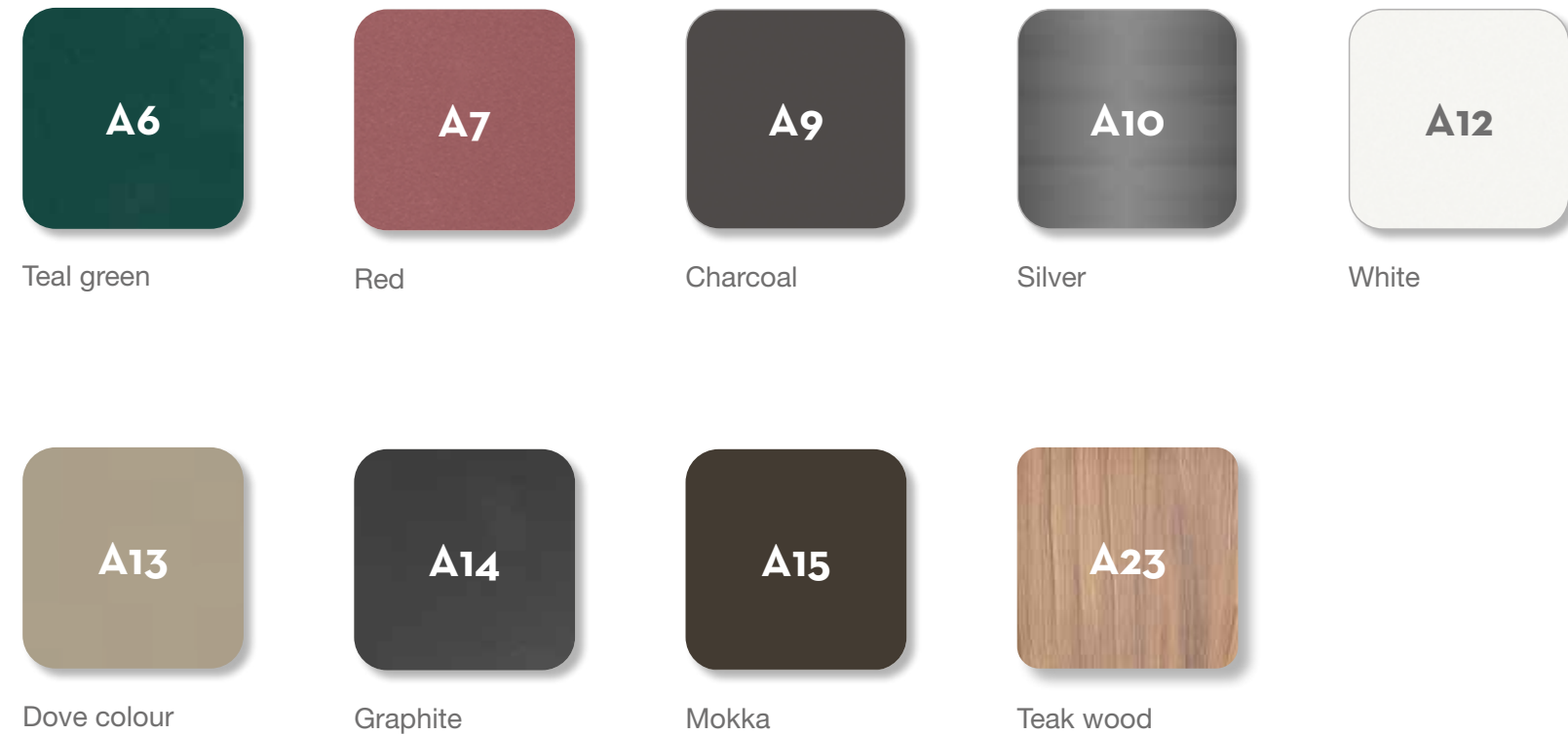

**Alluminio:** Grazie alla fusione di più leghe di alluminio che ne garantiscono solidità, maneggevolezza ed inattaccabilità alla ruggine, è un materiale di elevata qualità e permette di raggiungere i massimi risultati qualitativi ed estetici.

**Inox:** L'acciaio inossidabile è un materiale che, grazie alla sua alta resistenza alla corrosione e alle caratteristiche meccaniche di rilievo, risulta maggiormente duraturo e affidabile nel tempo.

**Acciaio:** Lega di ferro e carbonio con percentuale di carbonio inferiore al 2% trattata per resistere agli agenti atmosferici con il processo della cataforesi e verniciatura a polvere.

**Manutenzione:** Per mantenere a lungo il prodotto in buone condizioni, consigliamo una corretta pulizia periodica, particolarmente frequente in località caratterizzate da forte umidità e clima marino. Si raccomanda di pulire le superfici con un panno morbido utilizzando acqua o detersivi neutri. Prolungate ed ininterrotte esposizioni a intense radiazioni UV o a temperature molto rigide possono incidere sulle caratteristiche iniziali del rivestimento estetico colorato costituito da poliestere. Consigliamo di pulire e conservare in luoghi riparati i prodotti durante periodi d'inutilizzo prolungato e invernali.

**Aluminum:** Thanks to the fusion of several aluminum alloys that guarantee solidity, manageability and rust resistance, it is a material of high quality and allows to reach the maximum qualitative and aesthetic results.

**Inox:** Stainless steel is a material that, thanks to its high resistance to corrosion and to the mechanical characteristics of relief, is more durable and reliable over time.

**Steel:** Iron and carbon alloy with carbon percentage less than 2% treated to resist to the atmospheric agents with the cathoresis process and powder coating.

**Maintenance:** To keep the product in good condition for a long time, we recommend a regular cleaning period, particularly frequent in places characterized by high humidity and marine climate. We recommend cleaning the surfaces with a soft cloth using water or neutral detergents. Prolonged and uninterrupted exposures to intense UV radiation or at very low temperatures can affect the initial characteristics of the colored polyester coating. We recommend cleaning and storing products in sheltered areas during long periods of non-use and winter.

# Materials

Corde sintetiche / Synthetic ropes

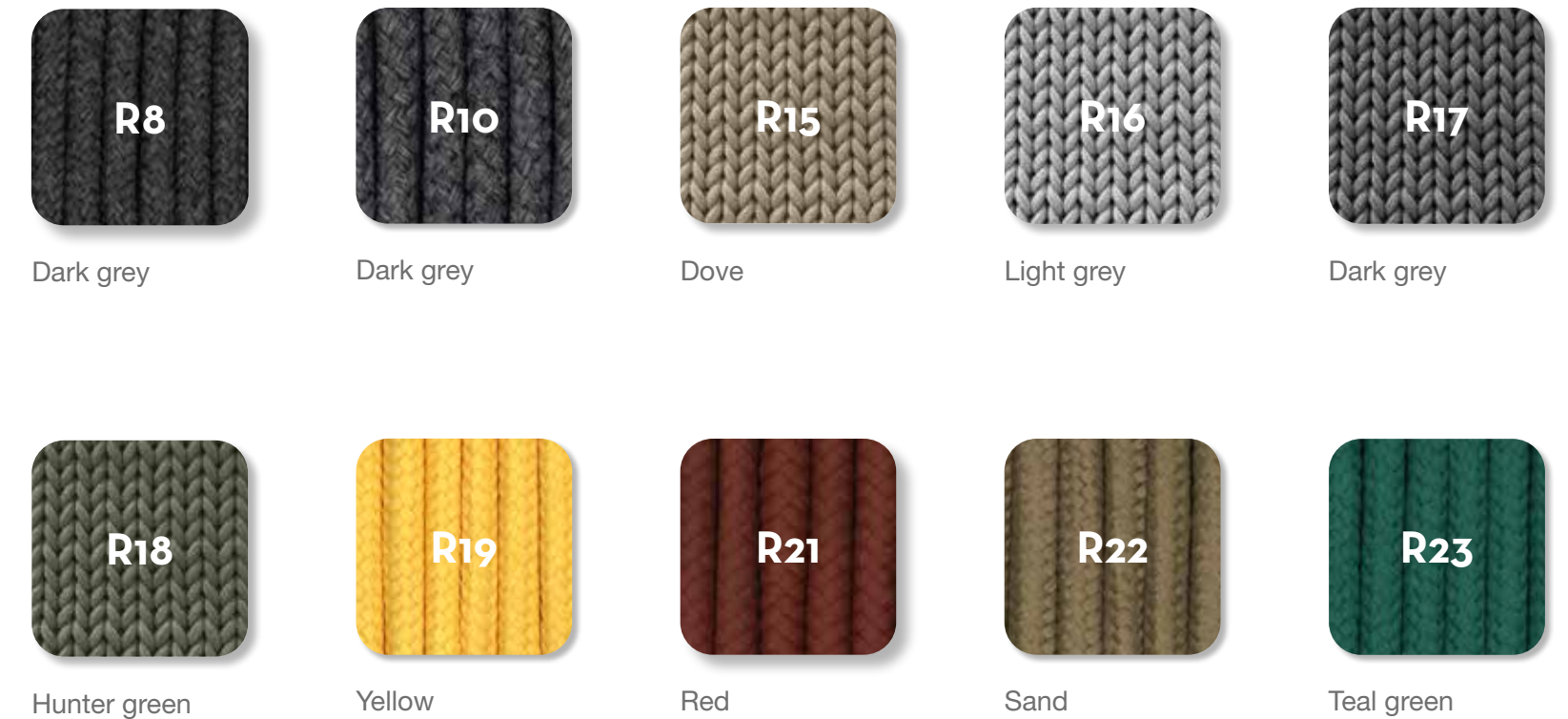

Beige

Doppia treccia costruita con anima in poliestere e copertura in propilene multi filamento. La fibra esterna di cui è composta è impermeabile e resistente ai raggi UV.

Si raccomanda di pulire con prodotto neutro e panno non abrasivo.

Double braid made with polyester core and multi-filament propylene cover. The external fiber is waterproof and resistant to UV rays.

It is recommended to clean with a neutral product and a non-abrasive cloth.

# Materials

Legni / Wood



L1

Teak

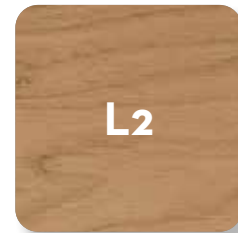

L2

Accoya natural teak colour

Teak: Materiale di elevata qualità ideale per la realizzazione di mobili da esterno perché estremamente resistente ai cambiamenti di temperatura, all'acqua, all'umidità e alla salsedine.

Trattandosi di un materiale naturale si potrebbero osservare variazioni di colore o anche crepe dovute al grado di umidità ed ai bruschi cambiamenti di temperatura. Qualora non ricevesse alcun trattamento di manutenzione, mediante l'applicazione periodica di comuni e specifici protettivi a base olio, la superficie potrebbe prendere una patina grigio argento che potrà essere eliminata con una leggera carteggiatura superficiale e successiva lucidatura con panno di iuta. Piccole macchie superficiali dovute ad olio o altri prodotti alimentari dovranno essere rimosse tempestivamente, prima che il legno possa assorbirle in profondità, carteggiando la superficie interessata e lucidandola successivamente con un panno di iuta.

Teak: High quality material suitable for outdoor furniture because it is extremely resistant to changes in temperature, water, humidity and saltiness.

Being a natural material, colour variations or even cracks due to the degree of humidity and sudden changes in temperature may be observed. If no maintenance treatment is received, through the periodic application of common and specific protective oil-based, the surface may take a silver-gray patina that can be easily removed with a light surface sanding down and subsequent polishing with a jute cloth. Small superficial stains due to oil or other food products must be removed promptly, before the wood can absorb them in depth, sanding down the affected surface and then polishing it with a jute cloth.

# Materials

Tappeti / Carpet



F1

Canvas



F2

Light grey



F3

Dark grey



F7

Red



F8

Dark green

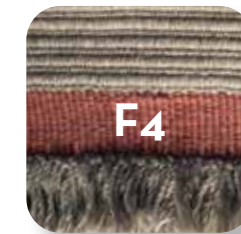

F4

Canvas



F6

Light grey



F6

Dark grey



F9

Dark green



F10

Beige barré

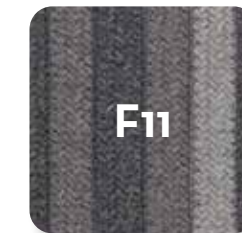

F11

Grey barré



F12

Red barré



F13

Green barré

I tappeti sono realizzati in filato di fibra sintetica, hanno un trattamento idrorepellente, antimacchia e antimuffa. Il filato in PP ha una resa ottimale in ambienti esterni, per durata e resistenza agli agenti atmosferici ed ha un'elevata stabilità ai raggi UV.

Manutenzione quotidiana: aspirapolvere senza spazzole.  
Manutenzione periodica: lavaggio a secco o pulizia a vapore.

Macchie: tamponare con un panno pulito; agire con detersivi specifici seguendo attentamente le istruzioni del produttore.

All the carpets are made of synthetic fabric and through a special treatment they are waterproof, stain-resistant and anti-bacterial. The PP yarn ensures an excellent performance in terms long-lasting durability, weather and UV rays resistance.

Daily cleaning: vacuum cleaner without brushes.  
Deeper cleaning: professional dry cleaning or steam cleaning.  
Stains: pat the area with a clean cloth; use specific detergents following the manufacturer's instructions.

# Materials

Tessuto 100% pl, idrorepellente / 100% pl fabric, water repellent



Il poliestere è un materiale adatto all'arredo esterno perchè semplice da pulire, trattare e lavare. Ha elevate caratteristiche meccaniche: resiste alla rottura, alla luce, all'abrasione, non si deforma in modo permanente ed ha un ottimo recupero elastico. È idrorepellente, quindi perfetto se installato vicino ad un bordo piscina o se esposto a situazioni climatiche avverse.

Prima di chiudere l'ombrellone è importante assicurarsi che il telo sia perfettamente asciutto. Durante i mesi di non utilizzo l'ombrellone deve essere riposto in un ambiente asciutto e protetto dalla relativa cover. Evitare il contatto prolungato con sostanze grasse e/o coloranti che potrebbero venire assorbite dal materiale di rivestimento e dare luogo a macchie permanenti, oltre che deteriorare la struttura del filato. Non usare solventi. Utilizzare acqua e detersivi liquidi non abrasivi con PH neutro e incolore. Eventualmente lasciare agire il detersivo alcuni minuti. Sciacquare abbondantemente con acqua a temperatura non superiore a 30°C.

Polyester is a material suitable for outdoor furniture because it is easy to clean, treat and wash. It has high flexural strength characteristics: it resists breakage, light, abrasion, does not deform permanently and has an excellent elastic shape recovery. It is water repellent, therefore perfect if installed near swimming pool areas or if exposed to adverse weather conditions.

Before closing the parasol it is important to make sure that the cloth is perfectly dry. During the months of not using the umbrella must be stored in a dry place and protected by the appropriate cover. Avoid prolonged contact with greasy substances which could be absorbed by the coating material and give rise to permanent stains, as well as deteriorating the yarn structure. Do not use solvents. Use water and non-abrasive liquid detergents with neutral PH and colourless. If necessary, allow the detergent to act for a few minutes. Rinse with water at a temperature not exceeding 30 ° C.

# Materials

Textilene

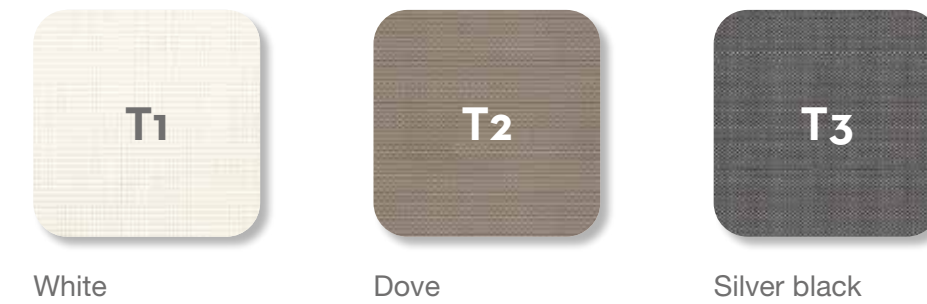

Il Textilene è una fibra di poliestere protetta da un rivestimento in PVC. Le fibre vengono poi legate insieme in modo da ottenere una sostanza fibrosa particolarmente solida e permanente, resistente allo stiramento ed immune da strappi. La caratteristica più importante è la sua elasticità, offre un'eccellente resistenza alle muffe e alle macchie, e presenta un trattamento superficiale contro la degradazione UV.

Il textilene può essere pulito semplicemente con un panno di spugna con acqua saponata. Abrasivi e solventi devono essere assolutamente evitati! Si asciuga molto rapidamente a causa della loro struttura aperta.

Textilene is a polyester fiber protected by a PVC coating. The fibers are bonded together so in order to obtain a particularly solid fibrous material which is durable, resistant to stretching and wear resistant too. The most important characteristic is its elasticity, offers excellent resistance to inhibits mold and stains, and has a surface treatment against UV degradation.

Textilene can simply be cleaned with a sponge cloth with soapy water. Abrasives and solvents must absolutely be avoided! It dries very quickly due to their open structure.

# Materials

Tessuto microforato / Micro-perforated fabric



White



Taupe



Red

Tessuto tecnico microforato in poliestere spalmato PVC per la protezione solare. Tessuto leggero filtrante per garantire il giusto apporto di luce naturale, elevata stabilità dimensionale e resistenza meccanica.

Equilibrio ideale tra protezione termica e comfort visivo, ottima visibilità verso l'esterno con una trama regolare. Stabile dimensionalmente. Resistente alle intemperie e ai raggi UV. Leggero, durevole, 100% riciclabile. Ignifugo.

Per la pulizia si consiglia di utilizzare un panno di spugna con acqua saponata. Abrasivi e solventi devono essere assolutamente evitati! Si asciuga molto rapidamente a causa della loro struttura aperta.

Micro-perforated technical fabric in PVC coated polyester for sun protection. Light filtering fabric to ensure the right amount of natural light, high dimensional stability and mechanical resistance.

Ideal balance between thermal protection and visual comfort, excellent visibility towards the outdoor with a regular weave. Stable dimensionally. Weatherproof and UV resistant. Lightweight, long lasting, 100% recyclable. Fireproof.

For cleaning we recommend using a sponge cloth with soapy water. Abrasives and solvents must be absolutely avoided! It dries very quickly due to their open structure.

100% Translucent polyethylene



White



Dove colour



Graphite

Il polietilene è un materiale plastico molto adatto all'arredo esterno. Ha una superficie particolarmente pratica, lavabile, resistente ai raggi UV e agli agenti atmosferici nel corso del tempo. Ha un'elevata resistenza agli urti, una resistenza eccellente alla corrosione e ai prodotti chimici.

Non è penetrabile da liquidi come acqua, soluzioni saline o alcool.

Non utilizzare acidi ossidanti, quali acido Nitrico, acido solforico o alogeni.

Polyethylene is a plastic material that is perfectly suitable for outdoor furniture. Its surface is particularly practical, washable, UV and weather-resistant over the time.

Not penetrable by liquids such as water, salt solutions or alcohol, this material stands out also for its high-impact resistance and its excellent resistance to corrosion and chemicals.

Do not use oxidising acids, such as nitric acid, sulphuric acid or halogens.

# Materials

Eco-resina / Eco-resin



Sand



Graphite



Red

Eco-resina è un mix di materiali 100% ecologici che riducono di oltre 2/3 il peso rispetto al tradizionale cemento, conservando la naturalezza e l'aspetto materico dello stesso.

Eco-Resina è una resina acrilica naturale a base d' acqua, non teme il gelo e la lunga esposizione al sole.

Tutti gli articoli trattati con più strati di vernici all'acqua, quindi tutto a basso impatto ambientale.

Pulire con un panno umido senza utilizzare solventi troppo aggressivi.

Eco-resin is a mix of 100% eco-friendly materials. Compared to traditional concrete, they are characterized by a reduced weight by more than 2/3, while preserving the naturalness and the material aspect of the cement.

Eco-Resin is a natural, water-based acrylic resin, resistant to frost and to long exposure to the sun.

All items are treated with several coats of water-based paints, guaranteeing a low environmental impact.

For proper maintenance it is recommended to clean it with a damp cloth avoiding the use of aggressive solvents.

Cemento alleggerito / Lightened concrete



Sand



Graphite



Red

Cemento alleggerito fibrorinforzato che lo rende il 30% più leggero rispetto al un classico manufatto in cemento. Le Vernici utilizzate sono specifiche per il cemento con protezione agli agenti atmosferici.

Pulire con un panno umido senza utilizzare solventi troppo aggressivi.

Abrasivi e solventi devono essere assolutamente evitati!

Fiber-reinforced lightweight concrete which makes it 30% lighter than a classic concrete artifact. The coatings used are specific for concrete with protection against atmospheric agents.

Clean with a damp cloth without using aggressive solvents.

Abrasives and solvents must be absolutely avoided!

# Materials

Cemento / Concrete



S30

Beige cement



S31

Grey cement



S36

Blue cement

Il cemento è un materiale naturale e, in quanto tale, durante il suo processo produttivo possono verificarsi leggere sfumature e variazioni delle tonalità dell'impasto cementizio, che caratteristica portante del materiale e della tecnologia.

Le fibre sono una componente dell'impasto cementizio e conferiscono al cemento Ductal la sua estrema resistenza e flessibilità. Se la finitura scelta è molto levigata, le fibre possono intravedersi sulla superficie e devono essere accettate come caratteristica intrinseca alla finitura.

I piani in cemento, specialmente di grandi dimensioni, non sono perfettamente planari a causa della natura stessa del materiale e della sua lavorazione artigianale.

Micro cavillature da ritiro, devono essere accettate come fenomeno naturale della lavorazione del materiale.

Piccoli fori e bolle possono apparire sulla superficie dei prodotti in cemento. Essi sono una naturale conseguenza del processo produttivo e parte integrante delle caratteristiche del materiale. Il loro aspetto e la loro quantità varia da finitura a finitura. I fori inferiori a 4 mm di diametro vengono lasciati tali, mentre di norma vengono stuccati quando superano il diametro di 5 mm.

Il cemento è un materiale poroso che tende ad assorbire i liquidi che entrano in contatto con la sua superficie, per questo va protetto con dei prodotti appositi; antidegrado ed antimacchia. È importante quindi evitare il ristagno dei liquidi sui piani e specialmente il contatto prolungato tra cemento e oggetti bagnati quali vasi, bottiglie, bicchieri o teli di plastica: una non corretta evaporazione dei liquidi può causare infatti macchie difficilmente removibili dai manufatti.

Eseguire una pulizia superficiale con l'utilizzo di una soluzione di acqua e detergente neutro con basso contenuto di cera (es. prodotti per pavimenti in marmo). Per macchie insistenti, è possibile utilizzare soluzioni che contengono ammoniaca/candeggina diluita al 10%, cioè 1 parte di candeggina su 10 parti di acqua.

Cement is a natural material and due to its nature it may present slight nuances and variations in its combination, which is a key characteristic of the material and production technology.

Fibres are a component of the cement mix and give the Ductal cement its extreme strength and flexibility.

If the chosen finish is highly polished, fibres may be visible on the surface and must be accepted as an intrinsic feature of the finish.

Cement top and flat surfaces, especially the large ones, are not perfectly flat due to the nature of the material and its craftsmanship.

Micro shrinkage cracks must be accepted as a natural phenomenon of the material's workmanship.

Small holes and bubbles may appear on the surface of cement products. They are a natural consequence of the production process and an integral part of the material's characteristics.

Their appearance and quantity varies from finish to finish.

Holes smaller than 4 mm in diameter are left as they are, while they are normally grouted when they exceed 5 mm in diameter.

Cement is a porous material that tends to absorb liquids which get in contact with its surface, which is why it must be protected with special products such as anti wear sealant and Anti stain sealant. It is therefore important to avoid the stagnation of liquids on the surfaces and especially the prolonged contact between cement and wet objects such as vases, bottles, glasses or plastic sheets: incorrect evaporation of liquids can cause stains that are difficult to remove.

Clean the surface with water and neutral detergent with a low content of wax (for ex. marble flooring products). Stubborn stains can be cleaned by using a solution containing 10% diluted ammonia/bleach, which is 1 part bleach for 10 parts water.

# Materials

Fiberglass



S48

glossy beige

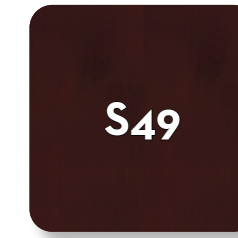

S49

glossy brown



S59

glossy nut



S64

glossy dove

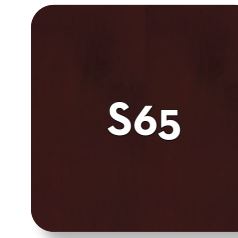

S65

glossy cinnamon



S66

glossy orange



S67

glossy green

Per la pulizia della fibra di vetro utilizzare un panno morbido e sapone neutro. Evitare prodotti abrasivi o acidi, che potrebbero danneggiare la superficie. Asciugare subito per prevenire aloni o macchie con un panno in microfibra.

For cleaning the fiberglass use a soft cloth and mild soap. Avoid abrasive or acid products, which could damage the surface. Dry immediately to prevent stains with a microfiber cloth.

# Materials

Terrazzo .....



Beige



Grey



Red

Terrazzo or graniglia is a material born thanks to the recycling of coloured cement waste and marble processing. It is obtained from a mixture of strongly binding cements, coloured in paste with natural oxides, and splinters recovered from the crushing of various types of marble. The terrazzo surface is then polished to obtain a finish that is pleasant to touch and to enhance the beauty of the aggregates.

Ordinary cleaning with water and neutral soap. Natural soap cleans, disinfects and nourishes the graniglia. DO NOT use aggressive detergents or acid/alkaline products that would compromise the limestone floor. The periodic use of neutral marble wax mixed in some water revives the colours and creates a patina effect that will protect the graniglia.

Terrazzo or Graniglia is a material created by recycling coloured cement waste and marble processing. It is obtained from a mixture of strongly binding cements, coloured with natural oxides, and splinters recovered from the crushing of various types of marble. The terrazzo surface is then polished to obtain a finish that is pleasant to touch and to enhance the beauty of the aggregates.

It can be cleaned with water and neutral soap. Natural soap cleans, disinfects and nourishes the graniglia. DO NOT use aggressive detergents or acid/alkaline products that would compromise the limestone floor. The periodic use of neutral marble wax mixed in some water revives the colours and creates a patina effect that will protect the graniglia.

# Materials

Cover .....



Realizzato con un accoppiato in 3 strati. I due strati esterni sono di propilene ed hanno funzione sia estetica, sia di protezione della membrana interna. La membrana interna è il tessuto tecnico che svolge la maggior parte del lavoro e che ha le proprietà di permeabilità all'aria e impermeabilità. Lavaggio: acqua e sapone, no lavaggio a macchina o a secco.

- Composizione tessuto: polipropilene
- Peso del tessuto: gr 170 circa
- Resistenza alla lacerazione (chiodo): N(MD) 180 - norma EN12310-1
- Resistenza alla penetrazione d'acqua: mm 1200 - norma EN 1928
- Permeabilità all'aria I/(mq-s): norma EDANA 140.2-99
- Trasmissione del vapore acqueo: Sd value m 0,051 - norma EN 12752.
- Protezione contro i raggi UV 500/1000 ore

It is made of three coupled layers. The external ones are made of propylene whose function is not only the aesthetic one, since it also protects the internal membrane. Such membrane is the technical fabric that plays the most important role: the permeability to air and the impermeability. Washing: to wash with soap and water, do not wash in washing machine or dry cleaning.

- Composition of the fabric: propylene
- Weight of the fabric: about gr 170
- Resistance to laceration (nail): N(MD) 180 - EN12310-1 Standard
- Resistant to water penetration: mm 1200 - EN 1928 Standard
- Resistance to air penetration I/(mq-s): EDANA 140.2-99 Standard
- Water vapor transmission: Sd value m 0,051 - regulation EN 12752.
- protection against UV 500/1000 hours

# Technical information

Legenda / Legend .....

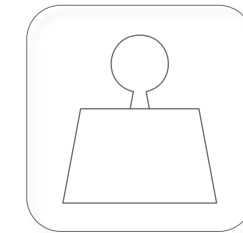

Peso netto KG  
Net weight KG

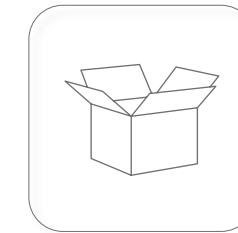

Unità per imballo  
Unit for box

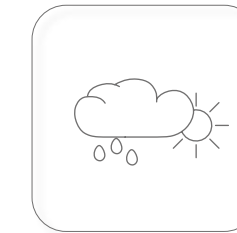

Resistente alle intemperie  
Weather-resistant

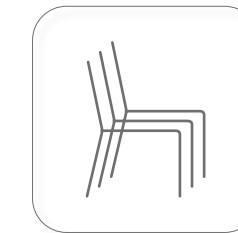

Impilabile  
Stackable

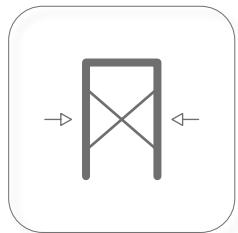

Pieghevole  
Folding

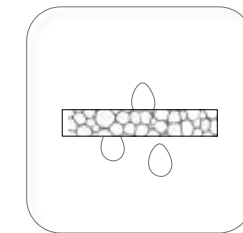

Imbottitura in dry foam  
Quick dry foam padding

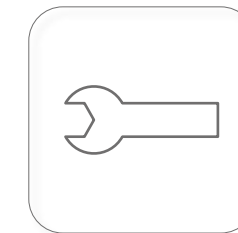

Articolo da assemblare  
To assemble

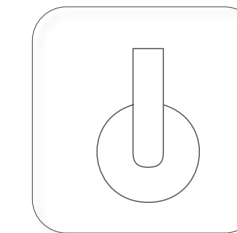

Piedini con ruote  
Feet with wheels

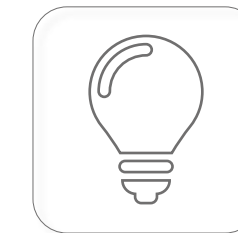

Provisto di illuminazione  
With lighting system



Alimentazione a batteria  
Battery powered

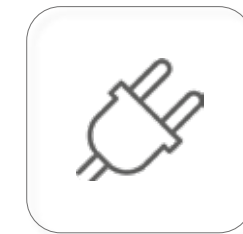

Alimentazione a 220V  
220V power supply

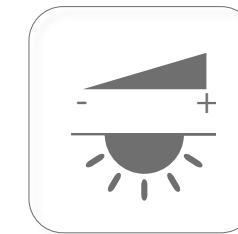

Luce dimmerabile  
Dimmable light

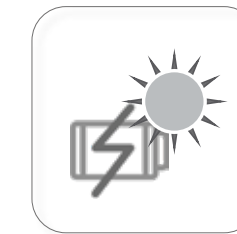

Ricarica solare  
Solar charging

Per ogni articolo sono indicate caratteristiche, dimensioni, peso, numero dei pezzi nell'imballo, materiali e colori.

For each item are provided features, sizes, weight, packaging, material, available colours.